

Technical sheet :

MANURE FORK WITH GRAPPLE









Customer benefits

- Rugged, multi-purpose attachment.
- Easy handling of compact manure.
- Total jaw opening allows working flush with walls.
- Versatile attachment that enables occasional square bale handling.
- Very good visibility, faster work.

Technical characteristics

- Massive structure and reinforced grapple for more longevity.
- Open structure.
- Very good manure holding by the grab.
- Adjustable grapple opening- more working accuracy.
- Forged tines & teeth- easy to dismantle.
- Well protected hydraulic components.

[The 3D picture at the top of this page is the reference FFGR 1500 / 600 - 52737500].

| Technical characteristics | | FFGR 1500 / 600 | FFGR 1500 / 900 | FFGR 1700 | FFGR 1950 | FFGR 1950 DA | FFGR 2100 | FFGR 2400 |
|------------------------------------|-----|---|---|---|---|---|---|---|
| Distance to center of gravity (mm) | | 361 | 370 | - | - | - | - | - |
| Capacities | | | | | | | | |
| Capacity (kg) | | 720 | 1115 | - | 1580 | 1580 | 1700 | 1700 |
| Heaped capacity (l) | | 600 | 990 | 1050 | 1000 | 1000 | 1100 | 1300 |
| Weight | | | | | | | | |
| Overall weight (kg) | | 340 | 437 | 505 | 477 | 530 | 492 | 528 |
| Weight and dimensions | | | | | | | | |
| Overall length (mm) | l1 | 1274 | 1321 | 1320 | 1322 | 1320 | 1322 | 1325 |
| Forks length (mm) | l | 810 | 810 | 810 | 810 | 810 | 810 | 810 |
| Fork spread (mm) | b5 | 225 | 225 | 225 | 225 | 225 | 225 | 225 |
| Width (mm) | | 1535 | 1627 | 1700 | 1950 | 1950 | 2100 | 2400 |
| Closed grab height (mm) | h33 | 879 | 1138 | 1124 | 1138 | 1124 | 1138 | 1138 |
| Opened grab height (mm) | h34 | 1675 | 1869 | 2093 | 1625 | 2093 | 1636 | 1615 |
| Working Parameters | | | | | | | | |
| Machine Equipment | |  |  |  |  |  |  |  |
| Teeth / Fingers | | 7 / 7 | 7 / 7 | 8 / 7 | 9 / 7 | 9 / 7 | 10 / 7 | 12 / 8 |

| Machines compatibility | FFGR 1500 / 600 | FFGR 1500 / 900 | FFGR 1700 | FFGR 1950 | FFGR 1950 DA | FFGR 2100 | FFGR 2400 |
|---------------------------------|-----------------|-----------------|-----------|-----------|--------------|-----------|-----------|
| Reference number | - | 52595596 | 751429 | 751404 | 751428 | 751403 | 751405 |
| All-Tach® | 52737500 | - | - | - | - | - | - |
| 4 point Carriage | 52742068 | - | - | - | - | - | - |
| Euro Carriage | 52742069 | - | - | - | - | - | - |
| AL530 | X | - | - | - | - | - | - |
| GCT 3-14 | X | - | - | - | - | - | - |
| GCT 3-14 + | X | - | - | - | - | - | - |
| MLA 5-50 H | X | - | - | - | - | - | - |
| MLT 420-60 H | - | X | - | - | - | - | - |
| MLT 625-75 H | - | - | X | - | X | - | - |
| MLT 630-115 | - | - | - | X | - | X | X |
| MLT 630-115 V | - | - | - | X | - | X | X |
| MLT 630-115 V CP | - | - | - | X | - | X | X |
| MLT 635-130 PS+ | - | - | - | - | - | X | X |
| MLT 635-140 V+ | - | - | - | - | - | X | X |
| MLT 730-115 V | - | - | - | X | - | X | X |
| MLT 730-115 V CP | - | - | - | X | - | X | X |
| MLT 733-115 LSU | - | - | - | - | - | X | X |
| MLT 737-130 PS+ | - | - | - | - | - | X | X |
| MLT 741-130 PS+ | - | - | - | - | - | X | X |
| MLT 741-140 V+ | - | - | - | - | - | X | X |
| MLT 841-145 PS+ | - | - | - | - | - | - | X |
| MLT 850-145 V+ | - | - | - | - | - | - | X |
| MLT 940-140 V+ | - | - | - | - | - | X | X |
| MLT 1041-145 PS+L | - | - | - | - | - | - | X |
| MLFX 625-75 H | - | - | X | - | X | - | - |
| MLFX 732 | - | - | - | - | - | X | X |
| MLFX 735 T LSU | - | - | - | - | - | X | X |
| MLFX 737-130 PS+ | - | - | - | - | - | X | X |
| MLFX 741 T LSU | - | - | - | - | - | X | X |
| MLFX 841 - 145 PS+ | - | - | - | - | - | - | X |
| MLFX 850-145 V+ | - | - | - | - | - | - | X |
| MLFX 1041-145 PS+L | - | - | - | - | - | - | X |
| ULM 412 H | X | - | - | - | - | - | - |
| ULM 412 H | X | - | - | - | - | - | - |
| ULM 415 H | X | - | - | - | - | - | - |
| ULM 415 H | X | - | - | - | - | - | - |
| MLT 630-105 ST4 OLD | - | - | - | X | - | X | - |
| MLT 630-105 V CP ST4 OLD | - | - | - | X | - | X | - |
| MLT 630-105 V ST4 OLD | - | - | - | X | - | X | - |
| MLT 635-130 PS+ ST4 OLD | - | - | - | - | - | X | X |
| MLT 635-140 V+ ST4 OLD | - | - | - | - | - | X | X |
| MLT 730-115 V CP ST4 OLD | - | - | - | X | - | X | - |
| MLT 730-115 V ST4 OLD | - | - | - | X | - | X | - |
| MLT 733-115 OLD | - | - | - | - | - | X | X |
| MLT 733-115 LSU ST4 OLD | - | - | - | - | - | X | X |
| MLT 733-115 ST4 OLD | - | - | - | - | - | X | X |
| MLT 737-130 PS+ ST4 OLD | - | - | - | - | - | X | X |
| MLT 741-140 V+ ST4 OLD | - | - | - | - | - | X | X |
| MLT 840-145 PS+ OLD | - | - | - | - | - | - | X |
| MLT 940-140 V+ ST4 OLD | - | - | - | - | - | X | X |
| MLT 1040-145 PS+ L OLD | - | - | - | - | - | - | X |
| MLFX 737-130 PS+ OLD | - | - | - | - | - | X | X |
| MLFX 741-140 V+ S1 OLD | - | - | - | - | - | X | X |
| MLFX 840-140 PS+ OLD | - | - | - | - | - | - | X |
| MLFX 1040-140 PS+ L OLD | - | - | - | - | - | - | X |

| TABLE SYMBOL | | | | | |
|---|----------------------------|---|-------------------------|---|---|
|  | No predisposition required |  | Hydraulic line |  | Return piping to hydraulic oil tank |
|  | Electric predisposition |  | Platform predisposition |  | Tyre handler, cylinder handler predisposition |

Manure Fork With Grapple - Dimensional drawing

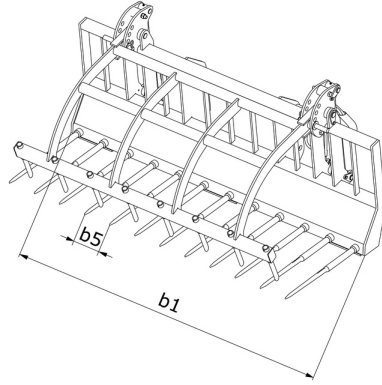



Head Office

B.P. 249 - 430 rue de l'Aubinière

44150 Ancenis Cedex - France

Tel: +33 (0)2 40 09 10 11 - Fax: +33 (0)2 40 09 10 97

www.manitou.com



This publication provides a description of the configuration versions and options for Manitou products, which may differ for equipment. The equipment presented in this brochure may be part of a series, as an option, or it may not be available, depending on the versions. Manitou reserves the right, at any time and without notice, to amend the specifications described and represented. The specifications provided do not bind the manufacturer. For more details, please contact your Manitou agent. This is not a contractually binding document. The presentation of the products is not contractually binding. List of specifications non-exhaustive. The logos as well as the visual identity of the company are owned by Manitou and cannot be used without authorisation. All rights reserved. The photos and diagrams contained in this brochure are only provided for consultation and information purposes.

MANITOU BF SA - Limited company with board of directors - Share capital: 39,668,399 euros - 857 802 508 RCS Nantes