

Ficha técnica :

# CONCRETE SKIP

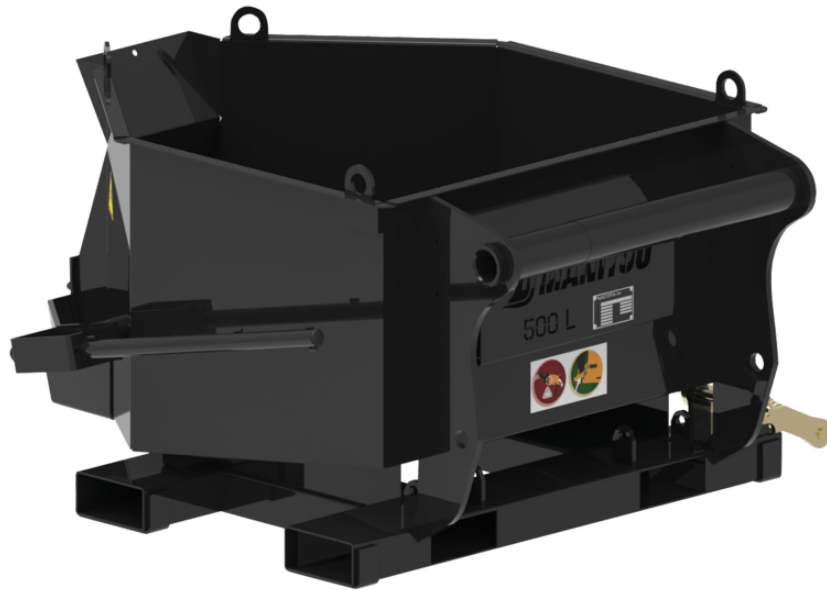



## Customer benefits

- Skip adapted to the needs of construction professionals.
- Compact attachment allowing work in window openings.
- Multi-purpose, for concrete and mortar.
- Optional: hydraulic opening for a controlled unloading ("H").
- Optional: flexible tube ("G") (1 m / 3 ft,  $\varnothing$ 200 mm / 8 in) for excellent accuracy.







## Technical characteristics

- 500 L / 18 ft<sup>3</sup> capacity.
- Carriage mounted (front position) or fork mounted (front and side unloading).
- Fork sleeves: 170 x 75 mm / 7 in x 3 in.
- Safety: attachment equipped with a fork lock system.
- Well-protected components.
- BBHG 500 MRT: equipped with a counterbalance valve.

Technical characteristics		BB 500	BB 500 MRT	BBG 500	BBH 500	BBHG 500	BBHG 500 MRT
Distance to center of gravity (mm)		556	555	598	578	618	621
<b>Capacities</b>							
Capacity (kg)		1200	1200	1200	1200	1200	1200
Heaped capacity (l)		500	500	500	500	500	500
<b>Weight</b>							
Overall weight (kg)		191	191	201	200	210	211
<b>Weight and dimensions</b>							
Overall height (mm)	h17	776	776	776	776	776	776
Overall length (mm)	l1	1466	1466	1466	1466	1466	1466
Width (mm)		1216	1216	1220	1110	1110	1110
<b>Working Parameters</b>							
Machine Equipment		✕	✕	✕			
Opening		Manual	Manual	Manual	Hydraulic	Hydraulic	Hydraulic
Flexible tube		No	No	Sí	No	Sí	Sí

Compatibilidad de la máquina	BB 500	BB 500 MRT	BBG 500	BBH 500	BBHG 500	BBHG 500 MRT
Reference number	52000637	-	52000639	52000638	52000640	-
MT 420 H	X	-	-	X	-	-
MT 625 H	X	-	X	X	X	-
MT 625 H Comfort	X	-	X	X	X	-
MT 625 HA	X	-	X	X	X	-
MT 730 H	X	-	X	X	X	-
MT 735 75D ST5	X	-	X	X	X	-
MT 930 H	X	-	X	X	X	-
MT 930 HA	X	-	X	X	X	-
MT 935 75D ST5	X	-	X	X	X	-
MT 1135 75 D	X	-	X	X	X	-
MT 1135 H 100D	X	-	X	X	X	-
MT 1335 75D ST5	X	-	X	X	X	-
MT 1335 100D ST5	X	-	X	X	X	-
MT 1335 H 75D ST5	X	-	X	X	X	-
MT 1335 H 100D ST5	X	-	X	X	X	-
MT-X 1440	X	-	X	X	X	-
MT-X 1440 A	X	-	X	X	X	-
MT-X 1840	X	-	X	X	X	-
MT-X 1840 A	X	-	X	X	X	-
MXT 840 K	X	-	-	-	-	-
MXT 840 P	X	-	-	-	-	-
MXT 1740 K	X	-	-	-	-	-
MXT 1740 P	X	-	-	-	-	-
MT 733 Easy <b>OLD</b>	X	-	X	X	X	-
MT 933 Easy <b>OLD</b>	X	-	-	-	X	-
MT 1033 easy <b>OLD</b>	X	-	X	X	X	-
MT 1135 <b>OLD</b>	X	-	X	X	X	-
MT 1135 H easy ST5 <b>OLD</b>	X	-	X	X	X	-
MT 1135 ST5 <b>OLD</b>	X	-	X	X	X	-
MT 1335 <b>OLD</b>	X	-	X	X	X	-
MT 1335 ST5 <b>OLD</b>	X	-	X	X	X	-
MT 1440 <b>OLD</b>	X	-	X	X	X	-
MT 1440 A <b>OLD</b>	X	-	X	X	X	-
MT 1440 HA <b>OLD</b>	X	-	X	X	X	-
MT 1840 <b>OLD</b>	X	-	X	X	X	-
MT 1840 A <b>OLD</b>	X	-	X	X	X	-
MT 1840 HA <b>OLD</b>	X	-	X	X	X	-
Reference number E-RECO	-	52000642	-	-	-	52000643
MRT 1645 75	-	X	-	-	-	X
MRT 1645 115	-	X	-	-	-	X
MRT 1845 75	-	X	-	-	-	X
MRT 1845 115	-	X	-	-	-	X
MRT 2145 115	-	X	-	-	-	X
MRT 2260	-	X	-	-	-	X
MRT 2260 e	-	X	-	-	-	X
MRT 2545 115	-	X	-	-	-	X
MRT 2570	-	X	-	-	-	X
MRT 2660	-	X	-	-	-	X
MRT 2660 e	-	X	-	-	-	X
MRT 3060	-	X	-	-	-	X
MRT 3570	-	X	-	-	-	X
MRT 3570 ES	-	X	-	-	-	X
MRT-X 1645	-	X	-	-	-	X
MRT-X 1845	-	X	-	-	-	X
MRT-X 2145	-	X	-	-	-	X
MRT-X 2260	-	X	-	-	-	X
MRT-X 2545	-	X	-	-	-	X
MRT-X 2570	-	X	-	-	-	X
MRT-X 2660	-	X	-	-	-	X
MRT-X 3060	-	X	-	-	-	X
MRT-X 3570	-	X	-	-	-	X
MRT-X 3570 ES	-	X	-	-	-	X

Compatibilidad de la máquina	BB 500	BB 500 MRT	BBG 500	BBH 500	BBHG 500	BBHG 500 MRT
MRT 1640 Easy T4 S2 360° <b>OLD</b>	-	X	-	-	-	X
MRT 1840 Easy T4 S2 360° <b>OLD</b>	-	X	-	-	-	X
MRT 1840 Easy T4 S2 400° <b>OLD</b>	-	X	-	-	-	X
MRT 2145 Easy T4 S2 360° <b>OLD</b>	-	X	-	-	-	X
MRT 2145 Easy T4 S2 400° <b>OLD</b>	-	X	-	-	-	X
MRT 2150 Privilege Plus <b>OLD</b>	-	X	-	-	-	X
MRT 2470 Privilege Plus <b>OLD</b>	-	X	-	-	-	X
MRT 2545 Easy T4 S2 360° <b>OLD</b>	-	X	-	-	-	X
MRT 2545 Easy T4 S2 400° <b>OLD</b>	-	X	-	-	-	X
MRT 2550 Privilege Plus <b>OLD</b>	-	X	-	-	-	X
MRT 3050 Privilege Plus <b>OLD</b>	-	X	-	-	-	X
MRT-X 1840 Easy 360° <b>OLD</b>	-	X	-	-	-	X
MRT-X 1840 Easy 400° <b>OLD</b>	-	X	-	-	-	X
MRT-X 2150 Privilege Plus <b>OLD</b>	-	X	-	-	-	X
MRT-X 2470 Privilege Plus <b>OLD</b>	-	X	-	-	-	X
MRT-X 2545 Easy 360° <b>OLD</b>	-	X	-	-	-	X
MRT-X 2545 Easy 400° <b>OLD</b>	-	X	-	-	-	X
MRT-X 2550 Privilege Plus <b>OLD</b>	-	X	-	-	-	X
MRT-X 3050 Privilege Plus <b>OLD</b>	-	X	-	-	-	X

TABLA DE SÍMBOLOS					
	No se requiere predisposición		Línea hidráulica		Retorno al depósito de aceite hidráulico
	Predisposición eléctrica		Predisposición de la plataforma		Predisposición manipulador de neumáticos, de cilindros



**Oficina Central**

B.P. 249 - 430 rue de l'Aubinière

44150 Ancenis Cedex - Francia

Tel.: 00 33 (0)2 40 09 10 11 - Fax: 00 33 (0)2 40 09 10 97

[www.manitou.com](http://www.manitou.com)



Esta publicación describe las versiones y posibilidades de configuración de los productos Manitou que puedan diferir en equipamiento. Los equipamientos presentados en este folleto pueden ser de serie, opcionales o no estar disponibles en algunas versiones. Manitou se reserva el derecho, en cualquier momento y sin previo aviso, de modificar las especificaciones descritas y representadas. Las especificaciones aportadas no comprometen al fabricante. Para más información, póngase en contacto con su concesionario Manitou. Documento no contractual. Presentación de los productos no contractual. Lista de especificaciones no exhaustiva. Los logos y la identidad visual de la empresa son propiedad de Manitou y no pueden ser utilizados sin autorización. Todos los derechos reservados. Las fotos y los esquemas contenidos en este folleto se ofrecen para consulta y a título indicativo solamente.

Manitou BF SA - Sociedad anónima con Consejo de Administración - Capital social: 39 668 399 euros - 857 802 508 RCS Nantes