

Fiche technique :

# CONCRETE SKIP

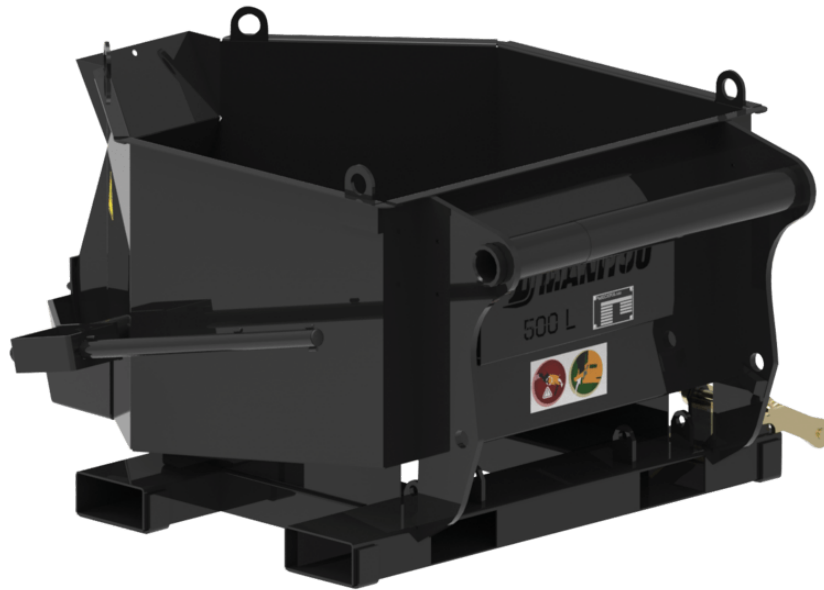

## Customer benefits

- Skip adapted to the needs of construction professionals.
- Compact attachment allowing work in window openings.
- Multi-purpose, for concrete and mortar.
- Optional: hydraulic opening for a controlled unloading ("H").
- Optional: flexible tube ("G") (1 m / 3 ft,  $\varnothing$ 200 mm / 8 in) for excellent accuracy.







## Technical characteristics

- 500 L / 18 ft<sup>3</sup> capacity.
- Carriage mounted (front position) or fork mounted (front and side unloading).
- Fork sleeves: 170 x 75 mm / 7 in x 3 in.
- Safety: attachment equipped with a fork lock system.
- Well-protected components.
- BBHG 500 MRT: equipped with a counterbalance valve.

Technical characteristics		BB 500	BB 500 MRT	BBG 500	BBH 500	BBHG 500	BBHG 500 MRT
Distance to center of gravity (mm)		556	555	598	578	618	621
Capacities							
Capacity (kg)		1200	1200	1200	1200	1200	1200
Heaped capacity (l)		500	500	500	500	500	500
Weight							
Overall weight (kg)		191	191	201	200	210	211
Weight and dimensions							
Overall height (mm)	h17	776	776	776	776	776	776
Overall length (mm)	l1	1466	1466	1466	1466	1466	1466
Width (mm)		1216	1216	1220	1110	1110	1110
Working Parameters							
Machine Equipment							
Opening		Manual	Manual	Manual	Hydraulic	Hydraulic	Hydraulic
Flexible tube		Non	Non	Oui	Non	Oui	Oui

Compatibilité machine	BB 500	BB 500 MRT	BBG 500	BBH 500	BBHG 500	BBHG 500 MRT
Reference number	52000637	-	52000639	52000638	52000640	-
MT 420 H	X	-	-	X	-	-
MT 625 H	X	-	X	X	X	-
MT 625 H Comfort	X	-	X	X	X	-
MT 625 HA	X	-	X	X	X	-
MT 730 H	X	-	X	X	X	-
MT 735 75D ST5	X	-	X	X	X	-
MT 930 H	X	-	X	X	X	-
MT 930 HA	X	-	X	X	X	-
MT 935 75D ST5	X	-	X	X	X	-
MT 1135 75 D	X	-	X	X	X	-
MT 1135 H 100D	X	-	X	X	X	-
MT 1335 75D ST5	X	-	X	X	X	-
MT 1335 100D ST5	X	-	X	X	X	-
MT 1335 H 75D ST5	X	-	X	X	X	-
MT 1335 H 100D ST5	X	-	X	X	X	-
MT-X 1440	X	-	X	X	X	-
MT-X 1440 A	X	-	X	X	X	-
MT-X 1840	X	-	X	X	X	-
MT-X 1840 A	X	-	X	X	X	-
MXT 840 K	X	-	-	-	-	-
MXT 840 P	X	-	-	-	-	-
MXT 1740 K	X	-	-	-	-	-
MXT 1740 P	X	-	-	-	-	-
MT 733 Easy <span>OLD</span>	X	-	X	X	X	-
MT 933 Easy <span>OLD</span>	X	-	-	-	X	-
MT 1033 easy <span>OLD</span>	X	-	X	X	X	-
MT 1135 <span>OLD</span>	X	-	X	X	X	-
MT 1135 H easy ST5 <span>OLD</span>	X	-	X	X	X	-
MT 1135 ST5 <span>OLD</span>	X	-	X	X	X	-
MT 1335 <span>OLD</span>	X	-	X	X	X	-
MT 1335 ST5 <span>OLD</span>	X	-	X	X	X	-
MT 1440 <span>OLD</span>	X	-	X	X	X	-
MT 1440 A <span>OLD</span>	X	-	X	X	X	-
MT 1440 HA <span>OLD</span>	X	-	X	X	X	-
MT 1840 <span>OLD</span>	X	-	X	X	X	-
MT 1840 A <span>OLD</span>	X	-	X	X	X	-
MT 1840 HA <span>OLD</span>	X	-	X	X	X	-
Reference number E-RECO	-	52000642	-	-	-	52000643
MRT 1645 75	-	X	-	-	-	X
MRT 1645 115	-	X	-	-	-	X
MRT 1845 75	-	X	-	-	-	X
MRT 1845 115	-	X	-	-	-	X
MRT 2145 115	-	X	-	-	-	X
MRT 2260	-	X	-	-	-	X
MRT 2260 e	-	X	-	-	-	X
MRT 2545 115	-	X	-	-	-	X
MRT 2570	-	X	-	-	-	X
MRT 2660	-	X	-	-	-	X
MRT 2660 e	-	X	-	-	-	X
MRT 3060	-	X	-	-	-	X
MRT 3570	-	X	-	-	-	X
MRT 3570 ES	-	X	-	-	-	X
MRT-X 1645	-	X	-	-	-	X
MRT-X 1845	-	X	-	-	-	X
MRT-X 2145	-	X	-	-	-	X
MRT-X 2260	-	X	-	-	-	X
MRT-X 2545	-	X	-	-	-	X
MRT-X 2570	-	X	-	-	-	X
MRT-X 2660	-	X	-	-	-	X
MRT-X 3060	-	X	-	-	-	X
MRT-X 3570	-	X	-	-	-	X
MRT-X 3570 ES	-	X	-	-	-	X

Compatibilité machine	BB 500	BB 500 MRT	BBG 500	BBH 500	BBHG 500	BBHG 500 MRT
MRT 1640 Easy T4 S2 360° <b>OLD</b>	-	X	-	-	-	X
MRT 1840 Easy T4 S2 360° <b>OLD</b>	-	X	-	-	-	X
MRT 1840 Easy T4 S2 400° <b>OLD</b>	-	X	-	-	-	X
MRT 2145 Easy T4 S2 360° <b>OLD</b>	-	X	-	-	-	X
MRT 2145 Easy T4 S2 400° <b>OLD</b>	-	X	-	-	-	X
MRT 2150 Privilège Plus <b>OLD</b>	-	X	-	-	-	X
MRT 2470 Privilège Plus <b>OLD</b>	-	X	-	-	-	X
MRT 2545 Easy T4 S2 360° <b>OLD</b>	-	X	-	-	-	X
MRT 2545 Easy T4 S2 400° <b>OLD</b>	-	X	-	-	-	X
MRT 2550 Privilège Plus <b>OLD</b>	-	X	-	-	-	X
MRT 3050 Privilège Plus <b>OLD</b>	-	X	-	-	-	X
MRT-X 1840 Easy 360° <b>OLD</b>	-	X	-	-	-	X
MRT-X 1840 Easy 400° <b>OLD</b>	-	X	-	-	-	X
MRT-X 2150 Privilège Plus <b>OLD</b>	-	X	-	-	-	X
MRT-X 2470 Privilège Plus <b>OLD</b>	-	X	-	-	-	X
MRT-X 2545 Easy 360° <b>OLD</b>	-	X	-	-	-	X
MRT-X 2545 Easy 400° <b>OLD</b>	-	X	-	-	-	X
MRT-X 2550 Privilège Plus <b>OLD</b>	-	X	-	-	-	X
MRT-X 3050 Privilège Plus <b>OLD</b>	-	X	-	-	-	X

TABLEAU DES SYMBOLES					
	Aucune prédisposition requise		Ligne hydraulique en tête de flèche		Retour hydraulique au réservoir
	Prédisposition électrique		Prédisposition nacelle		Prédisposition pinces à pneus, pinces à vérins



 **MANITOU**  
**HANDLING YOUR WORLD**

**Siège Social**

B.P. 249 - 430 rue de l'Aubinière

44150 Ancenis Cedex - France

Tel: +33 (0)2 40 09 10 11 - Fax: +33 (0)2 40 09 10 97

[www.manitou.com](http://www.manitou.com)



Cette publication présente le descriptif des versions et possibilités de configuration des produits Manitou qui peuvent différer en équipement. Les équipements présentés dans cette brochure peuvent être de série, en option, ou non disponibles suivant les versions. Manitou se réserve le droit, à tout moment et sans préavis, de modifier les spécifications décrites et représentées. Les spécifications portées n'engagent pas le constructeur. Pour plus de détails, contactez votre concessionnaire Manitou. Document non contractuel. Présentation des produits non contractuelle. Liste des spécifications non exhaustive. Les logos ainsi que l'identité visuelle de l'entreprise sont la propriété de Manitou et ne peuvent être utilisés sans autorisation. Tous droits réservés. Les photos et schémas contenus dans la présente brochure ne sont fournis qu'à des fins de consultation et à titre indicatif.

Manitou BF SA - Société anonyme à conseil d'administration - Capital social : 39 668 399 euros - 857 802 508 RCS Nantes