

Scheda tecnica :

# CONCRETE SKIP

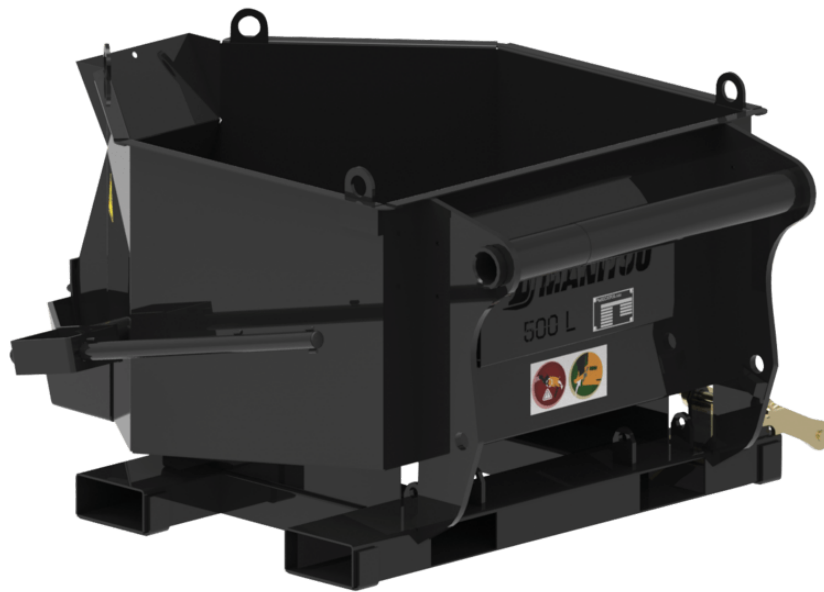

## Customer benefits

- Skip adapted to the needs of construction professionals.
- Compact attachment allowing work in window openings.
- Multi-purpose, for concrete and mortar.
- Optional: hydraulic opening for a controlled unloading ("H").
- Optional: flexible tube ("G") (1 m / 3 ft,  $\varnothing$ 200 mm / 8 in) for excellent accuracy.

## Technical characteristics







- 500 L / 18 ft<sup>3</sup> capacity.
- Carriage mounted (front position) or fork mounted (front and side unloading).
- Fork sleeves: 170 x 75 mm / 7 in x 3 in.
- Safety: attachment equipped with a fork lock system.
- Well-protected components.
- BBHG 500 MRT: equipped with a counterbalance valve.

 **ATTACHMENTS**

Technical characteristics		BB 500	BB 500 MRT	BBG 500	BBH 500	BBHG 500	BBHG 500 MRT
Distance to center of gravity (mm)		556	555	598	578	618	621
<b>Capacities</b>							
Capacity (kg)		1200	1200	1200	1200	1200	1200
Heaped capacity (l)		500	500	500	500	500	500
<b>Weight</b>							
Overall weight (kg)		191	191	201	200	210	211
<b>Weight and dimensions</b>							
Overall height (mm)	h17	776	776	776	776	776	776
Overall length (mm)	l1	1466	1466	1466	1466	1466	1466
Width (mm)		1216	1216	1220	1110	1110	1110
<b>Working Parameters</b>							
Machine Equipment							
Opening		Manual	Manual	Manual	Hydraulic	Hydraulic	Hydraulic
Flexible tube		No	No	Si	No	Si	Si

Compatibilità della macchina	BB 500	BB 500 MRT	BBG 500	BBH 500	BBHG 500	BBHG 500 MRT
Reference number	52000637	-	52000639	52000638	52000640	-
MT 420 H	X	-	-	X	-	-
MT 625 H	X	-	X	X	X	-
MT 625 H Comfort	X	-	X	X	X	-
MT 625 HA	X	-	X	X	X	-
MT 730 H	X	-	X	X	X	-
MT 735 75D ST5	X	-	X	X	X	-
MT 930 H	X	-	X	X	X	-
MT 930 HA	X	-	X	X	X	-
MT 935 75D ST5	X	-	X	X	X	-
MT 1135 75 D	X	-	X	X	X	-
MT 1135 H 100D	X	-	X	X	X	-
MT 1335 75D ST5	X	-	X	X	X	-
MT 1335 100D ST5	X	-	X	X	X	-
MT 1335 H 75D ST5	X	-	X	X	X	-
MT 1335 H 100D ST5	X	-	X	X	X	-
MT-X 735	X	-	X	X	X	-
MT-X 1135	-	-	X	X	X	-
MT-X 1440	X	-	X	X	X	-
MT-X 1440 A	X	-	X	X	X	-
MT-X 1840	X	-	X	X	X	-
MT-X 1840 A	X	-	X	X	X	-
MXT 840 K	X	-	-	-	-	-
MXT 840 P	X	-	-	-	-	-
MXT 1740 K	X	-	-	-	-	-
MXT 1740 P	X	-	-	-	-	-
MT 733 Easy <b>OLD</b>	X	-	X	X	X	-
MT 933 Easy <b>OLD</b>	X	-	-	-	X	-
MT 1033 easy <b>OLD</b>	X	-	X	X	X	-
MT 1135 <b>OLD</b>	X	-	X	X	X	-
MT 1135 H easy ST5 <b>OLD</b>	X	-	X	X	X	-
MT 1135 ST5 <b>OLD</b>	X	-	X	X	X	-
MT 1335 <b>OLD</b>	X	-	X	X	X	-
MT 1335 ST5 <b>OLD</b>	X	-	X	X	X	-
MT 1440 <b>OLD</b>	X	-	X	X	X	-
MT 1440 A <b>OLD</b>	X	-	X	X	X	-
MT 1440 HA <b>OLD</b>	X	-	X	X	X	-
MT 1840 <b>OLD</b>	X	-	X	X	X	-
MT 1840 A <b>OLD</b>	X	-	X	X	X	-
MT 1840 HA <b>OLD</b>	X	-	X	X	X	-
Reference number E-RECO	-	52000642	-	-	-	52000643
MRT 1645 75	-	X	-	-	-	X
MRT 1645 115	-	X	-	-	-	X
MRT 1845 75	-	X	-	-	-	X
MRT 1845 115	-	X	-	-	-	X
MRT 2145 115	-	X	-	-	-	X
MRT 2260	-	X	-	-	-	X
MRT 2260 e	-	X	-	-	-	X
MRT 2545 115	-	X	-	-	-	X
MRT 2570	-	X	-	-	-	X
MRT 2660	-	X	-	-	-	X
MRT 2660 e	-	X	-	-	-	X
MRT 3060	-	X	-	-	-	X
MRT 3570	-	X	-	-	-	X
MRT 3570 ES	-	X	-	-	-	X
MRT-X 1645	-	X	-	-	-	X
MRT-X 1845	-	X	-	-	-	X
MRT-X 2145	-	X	-	-	-	X
MRT-X 2260	-	X	-	-	-	X
MRT-X 2545	-	X	-	-	-	X
MRT-X 2570	-	X	-	-	-	X
MRT-X 2660	-	X	-	-	-	X
MRT-X 3060	-	X	-	-	-	X

Compatibilità della macchina	BB 500	BB 500 MRT	BBG 500	BBH 500	BBHG 500	BBHG 500 MRT
MRT-X 3570	-	X	-	-	-	X
MRT-X 3570 ES	-	X	-	-	-	X
MRT 1640 Easy T4 S2 360° <b>OLD</b>	-	X	-	-	-	X
MRT 1840 Easy T4 S2 360° <b>OLD</b>	-	X	-	-	-	X
MRT 1840 Easy T4 S2 400° <b>OLD</b>	-	X	-	-	-	X
MRT 2145 Easy T4 S2 360° <b>OLD</b>	-	X	-	-	-	X
MRT 2145 Easy T4 S2 400° <b>OLD</b>	-	X	-	-	-	X
MRT 2150 Privilege Plus <b>OLD</b>	-	X	-	-	-	X
MRT 2470 Privilege Plus <b>OLD</b>	-	X	-	-	-	X
MRT 2545 Easy T4 S2 360° <b>OLD</b>	-	X	-	-	-	X
MRT 2545 Easy T4 S2 400° <b>OLD</b>	-	X	-	-	-	X
MRT 2550 Privilege Plus <b>OLD</b>	-	X	-	-	-	X
MRT 3050 Privilege Plus <b>OLD</b>	-	X	-	-	-	X
MRT-X 1840 Easy 360° <b>OLD</b>	-	X	-	-	-	X
MRT-X 1840 Easy 400° <b>OLD</b>	-	X	-	-	-	X
MRT-X 2150 Privilege Plus <b>OLD</b>	-	X	-	-	-	X
MRT-X 2470 Privilege Plus <b>OLD</b>	-	X	-	-	-	X
MRT-X 2545 Easy 360° <b>OLD</b>	-	X	-	-	-	X
MRT-X 2545 Easy 400° <b>OLD</b>	-	X	-	-	-	X
MRT-X 2550 Privilege Plus <b>OLD</b>	-	X	-	-	-	X
MRT-X 3050 Privilege Plus <b>OLD</b>	-	X	-	-	-	X

TABELLA DEI SIMBOLI					
	Nessuna predisposizione richiesta		Linea idraulica		Ritorno idraulico al serbatoio
	Predisposizione elettrica		Predisposizione piattaforma		Predisposizione per la movimentazione dei pneumatici, dei cilindri



# **MANITOU** **HANDLING YOUR WORLD**

**Sede centrale**

MANITOU ITALIA Srl

Via Cristoforo Colombo 2, Loc. Cavazzona - 41013 CASTELFRANCO EMILIA (MO)

Tel: 059.95.98.11 - Fax 059.95.98.65

[www.manitou.com](http://www.manitou.com)



Questa pubblicazione presenta la descrizione delle versioni e delle possibilità di configurazione dei prodotti Manitou, che possono differire per attrezzature. Gli allestimenti presentati nel presente opuscolo possono essere di serie, optional o non disponibili, a seconda delle versioni. Manitou si riserva il diritto di modificare, in qualsiasi momento e senza alcun preavviso, le specifiche tecniche descritte e rappresentate. Le specifiche indicate non rappresentano alcun obbligo per il costruttore. Per maggiori dettagli, rivolgersi al proprio concessionario Manitou. Documento non contrattuale. Elenco delle specifiche non esaustivo. I loghi nonché l'identità visiva dell'azienda sono di proprietà di Manitou e non possono essere utilizzati senza autorizzazione. Tutti i diritti riservati. Le immagini e gli schemi contenuti nel presente opuscolo sono forniti esclusivamente a fini di consultazione e a titolo indicativo.

Manitou BF SA - Società anonima con consiglio di amministrazione. Capitale sociale: 39,668,399 euro - 857 802 508 RCS Nantes