

# CONCRETE SKIP

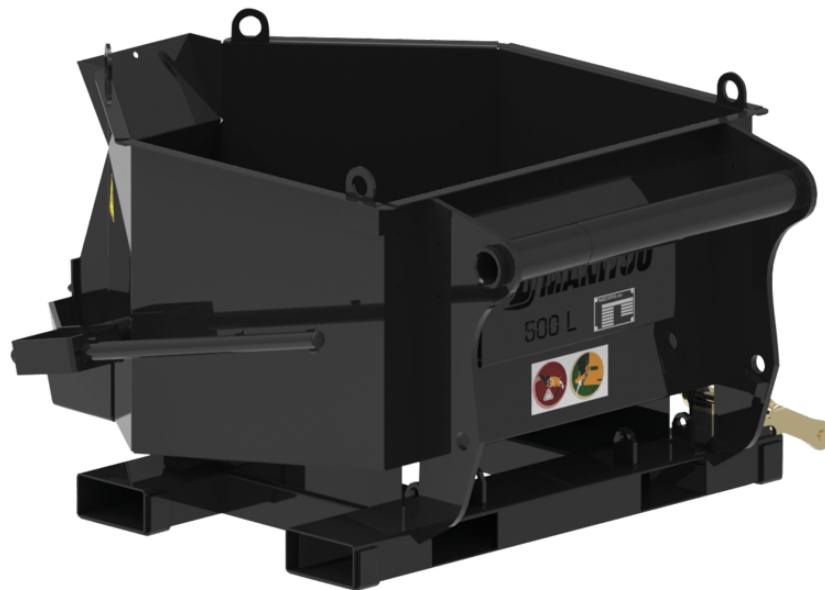





- Skip adapted to the needs of construction professionals.
- Compact attachment allowing work in window openings.
- Multi-purpose, for concrete and mortar.
- Optional: hydraulic opening for a controlled unloading ("H").
- Optional: flexible tube ("G") (1 m / 3 ft,  $\varnothing$ 200 mm / 8 in) for excellent accuracy.
- 500 L / 18 ft<sup>3</sup> capacity.
- Carriage mounted (front position) or fork mounted (front and side unloading).
- Fork sleeves: 170 x 75 mm / 7 in x 3 in.
- Safety: attachment equipped with a fork lock system.
- Well-protected components.
- BBHG 500 MRT: equipped with a counterbalance valve.



CONCRETE SKIP

	BB 500	BB 500 MRT	BBG 500	BBH 500	BBHG 500	BBHG 500 MRT

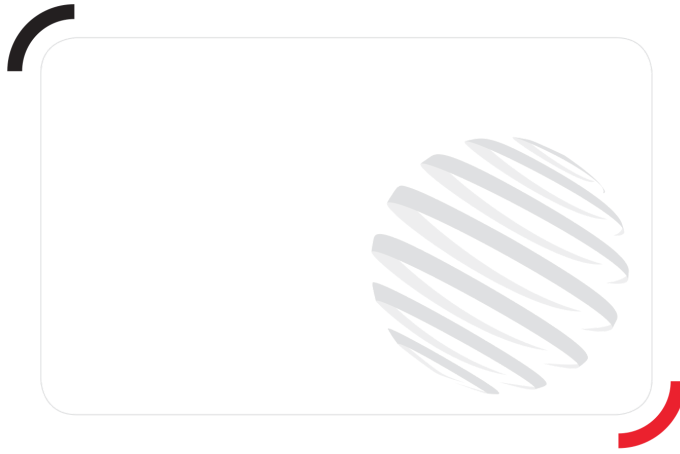

 **MANITOU**  
HANDLING YOUR WORLD

