

Ficha técnica :

CAZO AGRÍCOLA



Características técnicas

- Wide range of bucket capacities from 900 L / 32 ft³ to 3000 L / 106 ft³.
- Light material bucket suitable for handling materials with a density ≤ 1000 kg/m³ / 62 lb/ft³.
- Reinforced structure (base, blade and sides).
- "DA" = tip angle increased of 10°.
- Optional: 500 HB reversible wear plate.
- Note: road circulation kit mandatory in Italy. Contact your dealer.

[The 3D picture at the top of this page is the reference CBA 2500/2450 - 570554].







Beneficios para el cliente

- Daily use and hard working bucket.
- Ideal bucket for bulk products (cereals, woodchip, mineral feed etc.).
- Shape designed for quick loading and unloading operation.

| Características técnicas | | CBA 900 / 1500 | CBA 1500 / 2050 | CBA 1500 / 2050 DA | CBA 1500 / 2450 | CBA 1700 / 2100 | CBA 2000 / 2250 | CBA 2000 / 2450 | CBA 2500 / 2450 | CBA 3000 / 2500 |
|--------------------------------------|-----|----------------|-----------------|--------------------|-----------------|-----------------|-----------------|-----------------|-----------------|-----------------|
| Distancia al centro de gravedad (mm) | | 523 | 572 | 509 | 542 | 440 | 664 | 485 | 537 | 583 |
| Capacidad | | | | | | | | | | |
| Capacidad (kg) | | 886 | 1500 | 1500 | 1529 | 1703 | 1970 | 2010 | 2526 | 3023 |
| Capacidad del domo (l) | | 886 | 1500 | 1500 | 1529 | 1703 | 1970 | 2010 | 2526 | 3023 |
| Capacidad de golpeo (l) | | 672 | 1101 | 1101 | 1101 | 1271 | 1456 | 1484 | 1916 | 2342 |
| Weight | | | | | | | | | | |
| Peso (kg) | | 367 | 490 | 482 | 500 | 512 | 585 | 557 | 675 | 753 |
| Peso y dimensión | | | | | | | | | | |
| Altura total (mm) | h17 | 1029 | 1119 | 1119 | 997 | 1150 | 1104 | 1150 | 1250 | 1314 |
| Longitud total (mm) | l1 | 1154 | 1147 | 1147 | 1170 | 1190 | 1422 | 1204 | 1497 | 1733 |
| Anchura (mm) | | 1500 | 2050 | 2050 | 2450 | 2100 | 2250 | 2450 | 2450 | 2500 |
| Parámetros de trabajo | | | | | | | | | | |
| Equipamiento de máquina | | × | × | × | × | × | × | × | × | × |

| Compatibilidad de la máquina | CBA 900 / 1500 | CBA 1500 / 2050 | CBA 1500 / 2050 DA | CBA 1500 / 2450 | CBA 1700 / 2100 | CBA 2000 / 2250 | CBA 2000 / 2450 | CBA 2500 / 2450 | CBA 3000 / 2500 |
|---|----------------|-----------------|--------------------|-----------------|-----------------|-----------------|-----------------|-----------------|-----------------|
| Número de referencia | 570543 | 570546 | 653035 | 570547 | 570549 | 790540 | 570551 | 570553 | 570555 |
| Número de referencia del protector atomillado (LDR) | - | - | 52000489 | 570548 | 52610570 | 790541 | 570552 | 570554 | 500701 |
| Referencia cargadora compacta | 52658300 | - | - | - | - | - | - | - | - |
| ALT950 | - | - | - | X | - | X | X | - | - |
| MLA-T 533-145 V+ - ST5 | - | - | - | X | - | X | X | - | - |
| MLT 420-60 H | X | - | - | - | - | - | - | - | - |
| MLT 625-75 H | - | X | X | - | - | - | - | - | - |
| MLT 625 e | - | X | X | - | - | - | - | - | - |
| MLT 630-115 (S1) | - | - | - | X | X | X | X | - | - |
| MLT 630-115 (S2) | - | - | - | - | X | X | X | - | - |
| MLT 630-115 V (S1) | - | - | - | X | X | X | X | - | - |
| MLT 630-115 V (S2) | - | - | - | - | X | X | X | - | - |
| MLT 630-115 V CP (S1) | - | - | - | X | X | X | X | - | - |
| MLT 630-115 V CP (S2) | - | - | - | - | X | X | X | - | - |
| MLT 635-130 PS+ (S1) | - | - | - | X | - | - | X | X | - |
| MLT 635-130 PS+ (S2) | - | - | - | X | - | - | X | X | X |
| MLT 635-140 V+ (S1) | - | - | - | X | - | - | X | X | - |
| MLT 635-140 V+ (S2) | - | - | - | X | - | - | X | X | X |
| MLT 730-115 V (S1) | - | - | - | X | X | X | X | - | - |
| MLT 730-115 V (S2) | - | - | - | - | X | X | X | - | - |
| MLT 730-115 V CP (S1) | - | - | - | X | X | X | X | - | - |
| MLT 730-115 V CP (S2) | - | - | - | - | X | X | X | - | - |
| MLT 733-115 | - | - | - | X | X | X | X | X | - |
| MLT 733-115 (S2) | - | - | - | X | - | - | X | X | - |
| MLT 733-115 LSU (S1) | - | - | - | X | X | X | X | X | - |
| MLT 737-130 PS+ (S1) | - | - | - | X | X | X | X | X | X |
| MLT 738-130 PS+ (S1) | - | - | - | X | - | - | X | X | X |
| MLT 741-130 PS+ (S1) | - | - | - | X | X | X | X | X | X |
| MLT 741-140 V+ (S1) | - | - | - | X | X | X | X | X | X |
| MLT 742-130 PS+ (S1) | - | - | - | X | - | - | X | X | X |
| MLT 742-140 V+ (S1) | - | - | - | X | - | - | X | X | X |
| MLT 841-145 PS+ | - | - | - | - | - | - | X | X | X |
| MLT 850-145 V+ | - | - | - | - | - | - | - | X | X |
| MLT 937-115 (S1) | - | - | - | X | - | X | X | X | - |
| MLT 940-140 V+ (S1) | - | - | - | - | - | - | X | X | X |
| MLT 940-140 V+ (S2) | - | - | - | - | - | - | X | X | X |
| MLT 1041-145 PS+L | - | - | - | - | - | - | X | X | X |
| MLFX 625-75 H | - | X | X | - | - | - | - | - | - |
| MLFX 732 | - | - | - | X | - | - | X | X | - |
| MLFX 735 T LSU | - | - | - | X | - | - | X | X | - |
| MLFX 735 T LSU (70 KW) | - | - | - | X | - | - | - | X | - |
| MLFX 738-130 PS+ (S1) | - | - | - | X | - | - | X | X | X |
| MLFX 741 T LSU | - | - | - | - | - | - | X | X | X |
| MLFX 841 - 145 PS+ | - | - | - | - | - | - | X | X | X |
| MLFX 850-145 V+ | - | - | - | - | - | - | - | X | X |
| MLFX 1035 LT LSU | - | - | - | X | - | - | - | X | - |
| MLFX 1041-145 PS+L | - | - | - | - | - | - | X | X | X |
| MLT 630-105 ST4 OLD | - | - | - | X | X | X | X | - | - |
| MLT 630-105 V CP ST4 OLD | - | - | - | X | X | X | X | - | - |
| MLT 630-105 V ST4 OLD | - | - | - | X | X | X | X | - | - |
| MLT 635-130 PS+ ST4 OLD | - | - | - | X | - | - | X | X | - |
| MLT 635-140 V+ ST4 OLD | - | - | - | X | - | - | X | X | - |
| MLT 730-115 V CP ST4 OLD | - | - | - | X | X | X | X | - | - |
| MLT 730-115 V ST4 OLD | - | - | - | X | X | X | X | - | - |
| MLT 733-115 LSU ST4 OLD | - | - | - | X | X | X | X | X | - |
| MLT 733-115 ST4 OLD | - | - | - | X | X | X | X | X | - |
| MLT 737-130 PS+ ST4 OLD | - | - | - | X | X | X | X | X | X |
| MLT 741-140 V+ ST4 OLD | - | - | - | X | X | X | X | X | X |
| MLT 840-145 PS+ OLD | - | - | - | - | - | - | X | X | X |
| MLT 845-100 H OLD | - | - | - | X | - | - | X | X | X |
| MLT 845-120 OLD | - | - | - | X | - | - | X | X | X |
| MLT 940-140 V+ ST4 OLD | - | - | - | - | - | - | X | X | X |

| Compatibilidad de la máquina | CBA 900 / 1500 | CBA 1500 / 2050 | CBA 1500 / 2050 DA | CBA 1500 / 2450 | CBA 1700 / 2100 | CBA 2000 / 2250 | CBA 2000 / 2450 | CBA 2500 / 2450 | CBA 3000 / 2500 |
|-----------------------------------|----------------|-----------------|--------------------|-----------------|-----------------|-----------------|-----------------|-----------------|-----------------|
| MLT 1040-145 PS+ L OLD | - | - | - | - | - | - | X | X | X |
| MLT-X 737-130 PS+ OLD | - | - | - | X | X | X | X | X | X |
| MLT-X 737-130 PS+ (S2) OLD | - | - | - | X | X | X | X | X | - |
| MLT-X 741-140 V+ S1 OLD | - | - | - | X | X | X | X | X | X |
| MLT-X 840-140 PS+ OLD | - | - | - | - | - | - | X | X | X |
| MLT-X 845-120 OLD | - | - | - | X | - | - | X | X | X |
| MLT-X 845-120 H OLD | - | - | - | X | - | - | X | X | X |
| MLT-X 1040-140 PS+ L OLD | - | - | - | - | - | - | X | X | X |

| TABLA DE SÍMBOLOS | | | | | |
|---|-------------------------------|---|---------------------------------|---|--|
|  | No se requiere predisposición |  | Línea hidráulica |  | Retorno al depósito de aceite hidráulico |
|  | Predisposición eléctrica |  | Predisposición de la plataforma |  | Predisposición manipulador de neumáticos, de cilindros |

Cazo agrícola - Diagrama dimensional

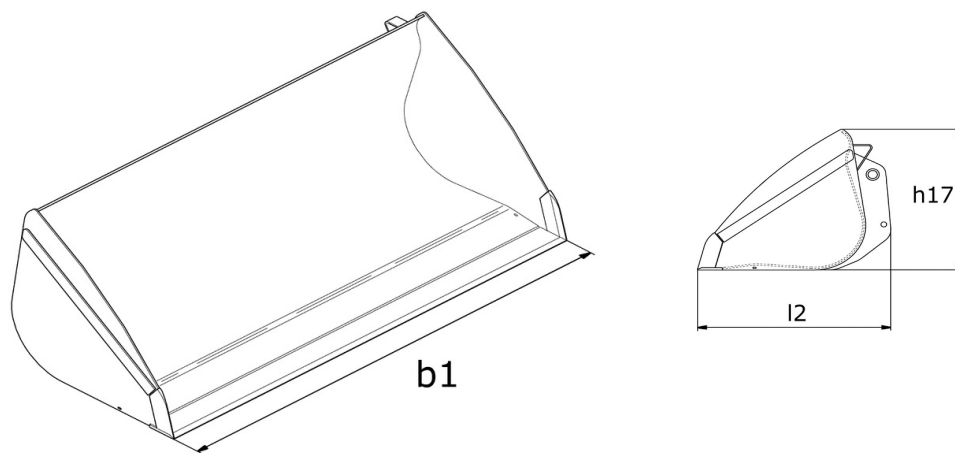



 **MANITOU**
HANDLING YOUR WORLD

Oficina Central

B.P. 249 - 430 rue de l'Aubinière

44150 Ancenis Cedex - Francia

Tel.: 00 33 (0)2 40 09 10 11 - Fax: 00 33 (0)2 40 09 10 97

www.manitou.com



Esta publicación describe las versiones y posibilidades de configuración de los productos Manitou que puedan diferir en equipamiento. Los equipamientos presentados en este folleto pueden ser de serie, opcionales o no estar disponibles en algunas versiones. Manitou se reserva el derecho, en cualquier momento y sin previo aviso, de modificar las especificaciones descritas y representadas. Las especificaciones aportadas no comprometen al fabricante. Para más información, póngase en contacto con su concesionario Manitou. Documento no contractual. Presentación de los productos no contractual. Lista de especificaciones no exhaustiva. Los logos y la identidad visual de la empresa son propiedad de Manitou y no pueden ser utilizados sin autorización. Todos los derechos reservados. Las fotos y los esquemas contenidos en este folleto se ofrecen para consulta y a título indicativo solamente.

Manitou BF SA - Sociedad anónima con Consejo de Administración - Capital social: 39 668 399 euros - 857 802 508 RCS Nantes