

Fiche technique :

GODET AGRICOLE



Caractéristiques techniques

- Large gamme de capacité de godet de 900 L / 32 ft³ à 3000 L / 106 ft³.
- Godet agricole adapté à la manutention de matériaux avec une densité $\leq 1000 \text{ kg/m}^3$ / 62 lb/ft³.
- Structure renforcée (base, lame et côtés).
- Le sigle DA signifie que l'angle de déversement a été amélioré de 10°.
- En option : lame réversible 500 HB pour une durée de vie encore plus longue (1).
- Note : Kit de circulation routière obligatoire en Italie. Contactez votre revendeur.
- Note : LDR = Lame Démontable Retournable.

Bénéfices client

- Godet adapté à une utilisation quotidienne et soutenue.
- Idéal pour la manipulation des produits en vrac (céréales, plaquettes de bois, compléments).
- Forme conçue pour des actions de chargement et de déchargement rapides.

Caractéristiques techniques		CBA 900 / 1500	CBA 1500 / 2050	CBA 1500 / 2050 DA	CBA 1500 / 2450	CBA 1700 / 2100	CBA 2000 / 2250	CBA 2000 / 2450	CBA 2500 / 2450	CBA 3000 / 2500
Distance du centre de gravité (mm)		523	572	509	542	440	664	485	537	583
Capacités										
Capacité (kg)		886	1500	1500	1529	1703	1970	2010	2526	3023
Capacité en dôme (l)		886	1500	1500	1529	1703	1970	2010	2526	3023
Capacité à ras (l)		672	1101	1101	1101	1271	1456	1484	1916	2342
Poids										
Poids (kg)		367	490	482	500	512	585	557	675	753
Poids et dimensions										
Hauteur hors tout (mm)	h17	1029	1119	1119	997	1150	1104	1150	1250	1314
Longueur hors-tout (mm)	l1	1154	1147	1147	1170	1190	1422	1204	1497	1733
Largeur (mm)		1500	2050	2050	2450	2100	2250	2450	2450	2500
Paramètres de travail										
Équipement machine requis		×	×	×	×	×	×	×	×	×

Compatibilité machine	CBA 900 / 1500	CBA 1500 / 2050	CBA 1500 / 2050 DA	CBA 1500 / 2450	CBA 1700 / 2100	CBA 2000 / 2250	CBA 2000 / 2450	CBA 2500 / 2450	CBA 3000 / 2500
Numéro de référence	570543	570546	653035	570547	570549	790540	570551	570553	570555
Numéro de référence avec la lame d'usure boulonnée (LDR)	-	-	52000489	570548	52610570	790541	570552	570554	500701
Référence tablier Skid Steer	52658300	-	-	-	-	-	-	-	-
ALT950	-	-	-	X	-	X	X	-	-
MLA-T 533-145 V+ - ST5	-	-	-	X	-	X	X	-	-
MLT 420-60 H	X	-	-	-	-	-	-	-	-
MLT 625-75 H	-	X	X	-	-	-	-	-	-
MLT 625 e	-	X	X	-	-	-	-	-	-
MLT 630-115 (S1)	-	-	-	X	X	X	X	-	-
MLT 630-115 (S2)	-	-	-	-	X	X	X	-	-
MLT 630-115 V (S1)	-	-	-	X	X	X	X	-	-
MLT 630-115 V (S2)	-	-	-	-	X	X	X	-	-
MLT 630-115 V CP (S1)	-	-	-	X	X	X	X	-	-
MLT 630-115 V CP (S2)	-	-	-	-	X	X	X	-	-
MLT 635-130 PS+ (S1)	-	-	-	X	-	-	X	X	-
MLT 635-130 PS+ (S2)	-	-	-	X	-	-	X	X	X
MLT 635-140 V+ (S1)	-	-	-	X	-	-	X	X	-
MLT 635-140 V+ (S2)	-	-	-	X	-	-	X	X	X
MLT 730-115 V (S1)	-	-	-	X	X	X	X	-	-
MLT 730-115 V (S2)	-	-	-	-	X	X	X	-	-
MLT 730-115 V CP (S1)	-	-	-	X	X	X	X	-	-
MLT 730-115 V CP (S2)	-	-	-	-	X	X	X	-	-
MLT 733-115	-	-	-	X	X	X	X	X	-
MLT 733-115 (S2)	-	-	-	X	-	-	X	X	-
MLT 733-115 LSU (S1)	-	-	-	X	X	X	X	X	-
MLT 737-130 PS+ (S1)	-	-	-	X	X	X	X	X	X
MLT 738-130 PS+ (S1)	-	-	-	X	-	-	X	X	X
MLT 741-130 PS+ (S1)	-	-	-	X	X	X	X	X	X
MLT 741-140 V+ (S1)	-	-	-	X	X	X	X	X	X
MLT 742-130 PS+ (S1)	-	-	-	X	-	-	X	X	X
MLT 742-140 V+ (S1)	-	-	-	X	-	-	X	X	X
MLT 841-145 PS+	-	-	-	-	-	-	X	X	X
MLT 850-145 V+	-	-	-	-	-	-	-	X	X
MLT 937-115 (S1)	-	-	-	X	-	X	X	X	-
MLT 940-140 V+ (S1)	-	-	-	-	-	-	X	X	X
MLT 940-140 V+ (S2)	-	-	-	-	-	-	X	X	X
MLT 1041-145 PS+L	-	-	-	-	-	-	X	X	X
MLFX 625-75 H	-	X	X	-	-	-	-	-	-
MLFX 732	-	-	-	X	-	-	X	X	-
MLFX 735 T LSU	-	-	-	X	-	-	X	X	-
MLFX 735 T LSU (70 KW)	-	-	-	X	-	-	-	X	-
MLFX 738-130 PS+ (S1)	-	-	-	X	-	-	X	X	X
MLFX 741 T LSU	-	-	-	-	-	-	X	X	X
MLFX 841 - 145 PS+	-	-	-	-	-	-	X	X	X
MLFX 850-145 V+	-	-	-	-	-	-	-	X	X
MLFX 1035 LT LSU	-	-	-	X	-	-	-	X	-
MLFX 1041-145 PS+L	-	-	-	-	-	-	X	X	X
MLT 630-105 ST4 OLD	-	-	-	X	X	X	X	-	-
MLT 630-105 V CP ST4 OLD	-	-	-	X	X	X	X	-	-
MLT 630-105 V ST4 OLD	-	-	-	X	X	X	X	-	-
MLT 635-130 PS+ ST4 OLD	-	-	-	X	-	-	X	X	-
MLT 635-140 V+ ST4 OLD	-	-	-	X	-	X	X	X	-
MLT 730-115 V CP ST4 OLD	-	-	-	X	X	X	X	-	-
MLT 730-115 V ST4 OLD	-	-	-	X	X	X	X	-	-
MLT 733-115 LSU ST4 OLD	-	-	-	X	X	X	X	X	-
MLT 733-115 ST4 OLD	-	-	-	X	X	X	X	X	-
MLT 737-130 PS+ ST4 OLD	-	-	-	X	X	X	X	X	X
MLT 741-140 V+ ST4 OLD	-	-	-	X	X	X	X	X	X
MLT 840-145 PS+ OLD	-	-	-	-	-	-	X	X	X
MLT 845-100 H OLD	-	-	-	X	-	-	X	X	X
MLT 845-120 OLD	-	-	-	X	-	-	X	X	X
MLT 940-140 V+ ST4 OLD	-	-	-	-	-	-	X	X	X

Compatibilité machine	CBA 900 / 1500	CBA 1500 / 2050	CBA 1500 / 2050 DA	CBA 1500 / 2450	CBA 1700 / 2100	CBA 2000 / 2250	CBA 2000 / 2450	CBA 2500 / 2450	CBA 3000 / 2500
MLT 1040-145 PS+ L OLD	-	-	-	-	-	-	X	X	X
MLT-X 737-130 PS+ OLD	-	-	-	X	X	X	X	X	X
MLT-X 737-130 PS+ (S2) OLD	-	-	-	X	X	X	X	X	-
MLT-X 741-140 V+ S1 OLD	-	-	-	X	X	X	X	X	X
MLT-X 840-140 PS+ OLD	-	-	-	-	-	-	X	X	X
MLT-X 845-120 OLD	-	-	-	X	-	-	X	X	X
MLT-X 845-120 H OLD	-	-	-	X	-	-	X	X	X
MLT-X 1040-140 PS+ L OLD	-	-	-	-	-	-	X	X	X

TABLEAU DES SYMBOLES					
	Aucune prédisposition requise		Ligne hydraulique en tête de flèche		Retour hydraulique au réservoir
	Prédisposition électrique		Prédisposition nacelle		Prédisposition pinces à pneus, pinces à vérins

Godet agricole - Schémas d'encombrement

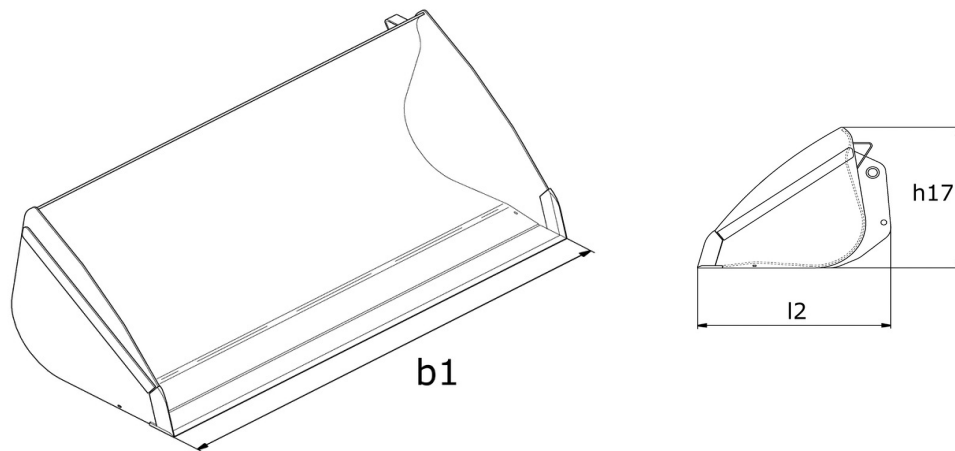



Siège Social

B.P. 249 - 430 rue de l'Aubinière
44150 Ancenis Cedex - France

Tel: +33 (0)2 40 09 10 11 - Fax: +33 (0)2 40 09 10 97

www.manitou.com



Cette publication présente le descriptif des versions et possibilités de configuration des produits Manitou qui peuvent différer en équipement. Les équipements présentés dans cette brochure peuvent être de série, en option, ou non disponibles suivant les versions. Manitou se réserve le droit, à tout moment et sans préavis, de modifier les spécifications décrites et représentées. Les spécifications portées n'engagent pas le constructeur. Pour plus de détails, contactez votre concessionnaire Manitou. Document non contractuel. Présentation des produits non contractuelle. Liste des spécifications non exhaustive. Les logos ainsi que l'identité visuelle de l'entreprise sont la propriété de Manitou et ne peuvent être utilisés sans autorisation. Tous droits réservés. Les photos et schémas contenus dans la présente brochure ne sont fournis qu'à des fins de consultation et à titre indicatif.

Manitou BF SA - Société anonyme à conseil d'administration - Capital social : 39 668 399 euros - 857 802 508 RCS Nantes