

Fiche technique :

GODET MULTIFONCTIONS AGRICOLE - WE



Bénéfices client

- Godet robuste et polyvalent particulièrement approprié pour l'utilisation en exploitation laitière et autres applications agricoles.
- Ouverture complète >90° et mâchoire puissante permettant de travailler au ras des murs.
- Parfait pour la manipulation de fumier, d'ensilage...
- Outil indispensable pour l'élevage de bétail.

Caractéristiques techniques







- Dents mécano-soudées -WE.
- Manutention de matériaux d'une densité de $\leq 1000 \text{ kg/m}^3$ / 62 lb/ft³.
- Côtés démontables, protection anti-déversement et bord de coupe boulonné 500 HB standard.
- Construction renforcée (base, lame et grappin).
- Cylindres nitrités, tous les axes avec montage "type construction".

MANITOU GROUP ATTACHMENTS

Caractéristiques techniques		BG 1500 / 600 WE	BG 1500 / 850 WE	BG 1850 / 1050 DA WE	BG 2100 / 1200 WE	BG 2300 / 1350 WE	BG 2450 / 1400 WE	BG 2450 / 1700 WE
Distance du centre de gravité (mm)		357	440	450	412	413	418	1021
Capacités								
Capacité nominale (kg)		550	850	1059	1200	1335	1426	1695
Capacité en dôme (l)		550	850	1059	1200	1335	1426	1695
Capacité à ras (l)		340	521	650	740	813	868	1150
Poids								
Poids (kg)		382	580	696	745	785	813	895
Poids et dimensions								
Longueur hors-tout (mm)	l1	1142	1263	1288	1280	1280	1280	1377
Largeur (mm)		1500	1500	1850	2100	2300	2450	2450
Hauteur grappin fermé (mm)	h33	798	1039	1033	1032	1031	1033	1124
Hauteur grappin ouvert (mm)	h34	1450	1777	1776	1776	1776	1776	1979
Paramètres de travail								
Équipement Machine								
Dents		6	6	7	8	8	8	9
Écartement minimal des fourches (mm)	b5	278	280	285	280	309	330	289
Écartement maximal des fourches (mm)	b5	280	280	285	280	309	330	289
Autres données pour les accessoires								
Plaque d'usure boulonnée (LDR)		Standard	Standard	Standard	Standard	Standard	Standard	Standard
Dureté de la plaque d'usure		500	500	500	500	500	500	500

Compatibilité machine	BG 1500 / 600 WE	BG 1500 / 850 WE	BG 1850 / 1050 DA WE	BG 2100 / 1200 WE	BG 2300 / 1350 WE	BG 2450 / 1400 WE	BG 2450 / 1700 WE
Numéro de référence	-	52651959	52647326	52647328	52647330	52647332	52549720
Référence tablier Skid Steer	-	52651960	-	-	-	-	-
All-Tach®	52736705	-	-	-	-	-	-
Tablier 4 points	52742062	-	-	-	-	-	-
Tablier Euro	52742063	-	-	-	-	-	-
AL530	X	-	-	-	-	-	-
ALT950	-	-	-	-	X	X	X
GCT 3-14	X	-	-	-	-	-	-
GCT 3-14	X	-	-	-	-	-	-
GCT 3-14 +	X	-	-	-	-	-	-
GCT 3-14+	X	-	-	-	-	-	-
MLA 5-50 H	X	-	-	-	-	-	-
MLA-T 533-145 V+ - ST5	-	-	-	-	X	X	X
MLT 420-60 H	-	X	-	-	-	-	-
MLT 625-75 H	-	-	X	-	-	-	-
MLT 630-115	-	-	-	X	X	X	-
MLT 630-115 V	-	-	-	X	X	X	-
MLT 630-115 V CP	-	-	-	X	X	X	-
MLT 635-130 PS+	-	-	-	-	-	X	X
MLT 635-140 V+	-	-	-	-	-	X	X
MLT 730-115 V	-	-	-	X	X	X	-
MLT 730-115 V CP	-	-	-	X	X	X	-
MLT 733-115 LSU	-	-	-	-	-	X	X
MLT 737-130 PS+	-	-	-	-	-	X	X
MLT 841-145 PS+	-	-	-	-	-	X	X
MLT 850-145 V+	-	-	-	-	-	-	X
MLT 937-115	-	-	-	-	-	X	X
MLT 940-140 V+	-	-	-	-	-	X	X
MLT 1041-145 PS+L	-	-	-	-	-	X	X
MLFX 625-75 H	-	-	X	-	-	-	-
MLFX 732	-	-	-	-	-	X	-
MLFX 735 T LSU	-	-	-	-	-	X	X
MLFX 737-130 PS+	-	-	-	-	-	X	X
MLFX 741 T LSU	-	-	-	-	-	X	X
MLFX 841 - 145 PS+	-	-	-	-	-	X	X
MLFX 850-145 V+	-	-	-	-	-	-	X
MLFX 1041-145 PS+L	-	-	-	-	-	X	X
ULM 412 H	X	-	-	-	-	-	-
ULM 412 H	X	-	-	-	-	-	-
ULM 415 H	X	-	-	-	-	-	-
ULM 415 H	X	-	-	-	-	-	-
MLT 630-105 ST4 OLD	-	-	-	X	X	X	-
MLT 630-105 V CP ST4 OLD	-	-	-	X	X	X	-
MLT 630-105 V ST4 OLD	-	-	-	X	X	X	-
MLT 635-130 PS+ ST4 OLD	-	-	-	-	-	X	X
MLT 635-140 V+ ST4 OLD	-	-	-	-	-	X	X
MLT 730-115 V CP ST4 OLD	-	-	-	X	X	X	-
MLT 730-115 V ST4 OLD	-	-	-	X	X	X	-
MLT 733-115 OLD	-	-	-	-	-	X	X
MLT 733-115 LSU ST4 OLD	-	-	-	-	-	X	X
MLT 733-115 ST4 OLD	-	-	-	-	-	X	X
MLT 737-130 PS+ ST4 OLD	-	-	-	-	-	X	X
MLT 741-140 V+ ST4 OLD	-	-	-	-	-	X	X
MLT 840-145 PS+ OLD	-	-	-	-	-	X	X
MLT 845-100 H OLD	-	-	-	-	-	X	X
MLT 845-120 OLD	-	-	-	-	-	X	X
MLT 940-140 V+ ST4 OLD	-	-	-	-	-	X	X

Compatibilité machine	BG 1500 / 600 WE	BG 1500 / 850 WE	BG 1850 / 1050 DA WE	BG 2100 / 1200 WE	BG 2300 / 1350 WE	BG 2450 / 1400 WE	BG 2450 / 1700 WE
MLT 1040-145 PS+ L OLD	-	-	-	-	-	X	X
MLT-X 737-130 PS+ OLD	-	-	-	-	-	X	X
MLT-X 741-140 V+ S1 OLD	-	-	-	-	-	X	X
MLT-X 840-140 PS+ OLD	-	-	-	-	-	X	X
MLT-X 845-120 OLD	-	-	-	-	-	X	X
MLT-X 845-120 H OLD	-	-	-	-	-	X	X
MLT-X 1040-140 PS+ L OLD	-	-	-	-	-	X	X

TABLEAU DES SYMBOLES					
	Aucune prédisposition requise		Ligne hydraulique en tête de flèche		Retour hydraulique au réservoir
	Prédisposition électrique		Prédisposition nacelle		Prédisposition pinces à pneus, pinces à vérins

Godet multifonctions agricole - WE - Schémas d'encombrement

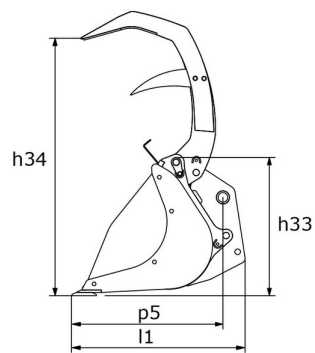
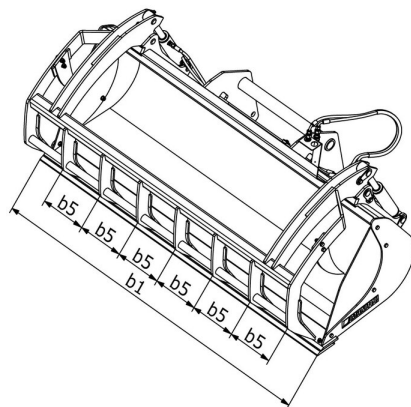



Siège Social

B.P. 249 - 430 rue de l'Aubinière

44150 Ancenis Cedex - France

Tel: +33 (0)2 40 09 10 11 - Fax: +33 (0)2 40 09 10 97

www.manitou.com



Cette publication présente le descriptif des versions et possibilités de configuration des produits Manitou qui peuvent différer en équipement. Les équipements présentés dans cette brochure peuvent être de série, en option, ou non disponibles suivant les versions. Manitou se réserve le droit, à tout moment et sans préavis, de modifier les spécifications décrites et représentées. Les spécifications portées n'engagent pas le constructeur. Pour plus de détails, contactez votre concessionnaire Manitou. Document non contractuel. Présentation des produits non contractuelle. Liste des spécifications non exhaustive. Les logos ainsi que l'identité visuelle de l'entreprise sont la propriété de Manitou et ne peuvent être utilisés sans autorisation. Tous droits réservés. Les photos et schémas contenus dans la présente brochure ne sont fournis qu'à des fins de consultation et à titre indicatif.

Manitou BF SA - Société anonyme à conseil d'administration - Capital social : 39 668 399 euros - 857 802 508 RCS Nantes