

Fiche technique :

# AGRICULTURAL MULTIFUNCTION GRAB BUCKET - WE



## Customer benefits

- Robust and versatile bucket suitable for dairy use and different agricultural applications.
- Complete opening >90° and powerful jaw allows working flush with walls.
- Perfect for handling wet manure, silage....
- Must-have tool for livestock farm.

## Technical characteristics







- Welded teeth -WE.
- Handling materials with a density  $\leq 1000 \text{ kg/m}^3 / 62 \text{ lb/ft}^3$ .
- Dismountable sides, spill guard and 500 HB bolt-on cutting edge standard.
- Reinforced construction (base, blade and grab).
- Nitritized cylinders, all pins with "construction type" mounting.

[The 3D picture at the top of this page is the reference BG 1850 / 1050 DA WE - 52647326].

Technical characteristics		BG 1500 / 600 WE	BG 1500 / 850 WE	BG 1850 / 1050 DA WE	BG 2100 / 1200 WE	BG 2300 / 1350 WE	BG 2450 / 1400 WE	BG 2450 / 1700 WE
Distance to center of gravity (mm)		357	440	450	412	413	418	1021
<b>Capacities</b>								
Capacity (kg)		550	850	1059	1200	1335	1426	1695
Heaped capacity (l)		550	850	1059	1200	1335	1426	1695
Struck capacity (l)		340	521	650	740	813	868	1150
<b>Weight</b>								
Overall weight (kg)		382	580	696	745	785	813	895
<b>Weight and dimensions</b>								
Overall length (mm)	l1	1142	1263	1288	1280	1280	1280	1377
Width (mm)		1500	1500	1850	2100	2300	2450	2450
Closed grab height (mm)	h33	798	1039	1033	1032	1031	1033	1124
Opened grab height (mm)	h34	1450	1777	1776	1776	1776	1776	1979
<b>Working Parameters</b>								
Machine Equipment								
Teeth		6	6	7	8	8	8	9
Fork spread minimum (mm)	b5	278	280	285	280	309	330	289
Fork spread maximum (mm)	b5	280	280	285	280	309	330	289
<b>Other Data for Attachments</b>								
Bolted wearplate (LDR)		Standard	Standard	Standard	Standard	Standard	Standard	Standard
Wear plate hardness		500	500	500	500	500	500	500

Compatibilité machine	BG 1500 / 600 WE	BG 1500 / 850 WE	BG 1850 / 1050 DA WE	BG 2100 / 1200 WE	BG 2300 / 1350 WE	BG 2450 / 1400 WE	BG 2450 / 1700 WE
Reference number	-	52651959	52647326	52647328	52647330	52647332	52549720
Skid Steer Camage reference	-	52651960	-	-	-	-	-
All-Tach®	52736705	-	-	-	-	-	-
4 point Camage	52742062	-	-	-	-	-	-
Euro Camage	52742063	-	-	-	-	-	-
AL530	X	-	-	-	-	-	-
ALT950	-	-	-	-	X	X	X
GCT 3-14	X	-	-	-	-	-	-
GCT 3-14	X	-	-	-	-	-	-
GCT 3-14 +	X	-	-	-	-	-	-
GCT 3-14+	X	-	-	-	-	-	-
MLA 5-50 H	X	-	-	-	-	-	-
MLA-T 533-145 V+ - ST5	-	-	-	-	X	X	X
MLT 420-60 H	-	X	-	-	-	-	-
MLT 625-75 H	-	-	X	-	-	-	-
MLT 630-115	-	-	-	X	X	X	-
MLT 630-115 V	-	-	-	X	X	X	-
MLT 630-115 V CP	-	-	-	X	X	X	-
MLT 635-130 PS+	-	-	-	-	-	X	X
MLT 635-140 V+	-	-	-	-	-	X	X
MLT 730-115 V	-	-	-	X	X	X	-
MLT 730-115 V CP	-	-	-	X	X	X	-
MLT 733-115 LSU	-	-	-	-	-	X	X
MLT 737-130 PS+	-	-	-	-	-	X	X
MLT 841-145 PS+	-	-	-	-	-	X	X
MLT 850-145 V+	-	-	-	-	-	-	X
MLT 940-140 V+	-	-	-	-	-	X	X
MLT 1041-145 PS+L	-	-	-	-	-	X	X
MLFX 625-75 H	-	-	X	-	-	-	-
MLFX 732	-	-	-	-	-	X	-
MLFX 735 T LSU	-	-	-	-	-	X	X
MLFX 737-130 PS+	-	-	-	-	-	X	X
MLFX 741 T LSU	-	-	-	-	-	X	X
MLFX 841 - 145 PS+	-	-	-	-	-	X	X
MLFX 850-145 V+	-	-	-	-	-	-	X
MLFX 1041-145 PS+L	-	-	-	-	-	X	X
ULM 412 H	X	-	-	-	-	-	-
ULM 412 H	X	-	-	-	-	-	-
ULM 415 H	X	-	-	-	-	-	-
ULM 415 H	X	-	-	-	-	-	-
MLT 630-105 ST4 <b>OLD</b>	-	-	-	X	X	X	-
MLT 630-105 V CP ST4 <b>OLD</b>	-	-	-	X	X	X	-
MLT 630-105 V ST4 <b>OLD</b>	-	-	-	X	X	X	-
MLT 635-130 PS+ ST4 <b>OLD</b>	-	-	-	-	-	X	X
MLT 635-140 V+ ST4 <b>OLD</b>	-	-	-	-	-	X	X
MLT 730-115 V CP ST4 <b>OLD</b>	-	-	-	X	X	X	-
MLT 730-115 V ST4 <b>OLD</b>	-	-	-	X	X	X	-
MLT 733-115 <b>OLD</b>	-	-	-	-	-	X	X
MLT 733-115 LSU ST4 <b>OLD</b>	-	-	-	-	-	X	X
MLT 733-115 ST4 <b>OLD</b>	-	-	-	-	-	X	X
MLT 737-130 PS+ ST4 <b>OLD</b>	-	-	-	-	-	X	X
MLT 741-140 V+ ST4 <b>OLD</b>	-	-	-	-	-	X	X
MLT 840-145 PS+ <b>OLD</b>	-	-	-	-	-	X	X
MLT 845-100 H <b>OLD</b>	-	-	-	-	-	X	X
MLT 845-120 <b>OLD</b>	-	-	-	-	-	X	X
MLT 940-140 V+ ST4 <b>OLD</b>	-	-	-	-	-	X	X
MLT 1040-145 PS+ L <b>OLD</b>	-	-	-	-	-	X	X

Compatibilité machine	BG 1500 / 600 WE	BG 1500 / 850 WE	BG 1850 / 1050 DA WE	BG 2100 / 1200 WE	BG 2300 / 1350 WE	BG 2450 / 1400 WE	BG 2450 / 1700 WE
MLT-X 737-130 PS+ <b>OLD</b>	-	-	-	-	-	X	X
MLT-X 741-140 V+ S1 <b>OLD</b>	-	-	-	-	-	X	X
MLT-X 840-140 PS+ <b>OLD</b>	-	-	-	-	-	X	X
MLT-X 845-120 <b>OLD</b>	-	-	-	-	-	X	X
MLT-X 845-120 H <b>OLD</b>	-	-	-	-	-	X	X
MLT-X 1040-140 PS+ L <b>OLD</b>	-	-	-	-	-	X	X

TABLEAU DES SYMBOLES					
	Aucune prédisposition requise		Ligne hydraulique en tête de flèche		Retour hydraulique au réservoir
	Prédisposition électrique		Prédisposition nacelle		Prédisposition pinces à pneus, pinces à vérins

### Agricultural Multifunction Grab Bucket - WE - Schémas d'encombrement

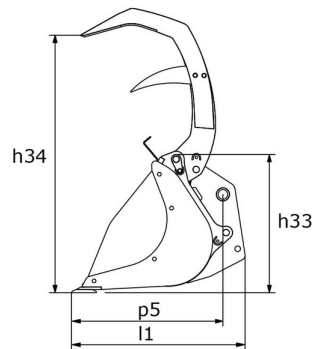



**Siège Social**

B.P. 249 - 430 rue de l'Aubinière

44150 Ancenis Cedex - France

Tel: +33 (0)2 40 09 10 11 - Fax: +33 (0)2 40 09 10 97

[www.manitou.com](http://www.manitou.com)



Cette publication présente le descriptif des versions et possibilités de configuration des produits Manitou qui peuvent différer en équipement. Les équipements présentés dans cette brochure peuvent être de série, en option, ou non disponibles suivant les versions. Manitou se réserve le droit, à tout moment et sans préavis, de modifier les spécifications décrites et représentées. Les spécifications portées n'engagent pas le constructeur. Pour plus de détails, contactez votre concessionnaire Manitou. Document non contractuel. Présentation des produits non contractuelle. Liste des spécifications non exhaustive. Les logos ainsi que l'identité visuelle de l'entreprise sont la propriété de Manitou et ne peuvent être utilisés sans autorisation. Tous droits réservés. Les photos et schémas contenus dans la présente brochure ne sont fournis qu'à des fins de consultation et à titre indicatif.

Manitou BF SA - Société anonyme à conseil d'administration - Capital social : 39 668 399 euros - 857 802 508 RCS Nantes