

Ficha técnica :

WRAPPED BALE CLAMP





Customer benefits

- Easy to use and competitive attachment.
- Powerful double effect cylinder allows the manipulation of very heavy bales.
- Rounded and articulated clamp designed to fit the shape of every bale.
- Smooth structure that avoids any perforation of plastic film.







Technical characteristics

- Self-lubricated anti-wear ring that improves the longevity of the attachment.
- Excellent lifting capacity from 800 kg / 1764 lb up to 1000 kg / 2205 lb.
- Welded monobloc chassis.
- CLBW 800 : handles wrapped bale with \varnothing from 0,85 m / 3 ft to 1,45 m / 5 ft.
- CLBW 1500 : handles wrapped bale with \varnothing from 1 m / 3 ft to 1,7 m / 6 ft.

Capacities		CLBW 800	CLBW 1500
Capacity (kg)		800	1500
Weight			
Overall weight (kg)		227	251
Weight and dimensions			
Overall height (mm)	h17	810	810
Overall length (mm)	l1	1386	1490
Width (mm)		1587	1587
Working Parameters			
Machine Equipment			
Opening minimum (mm)		249	510
Opening maximum (mm)		1503	1846
1 Wrapped bale max diameter (mm)		1450	1700
1 Wrapped bale min diameter (mm)		850	1000

Compatibilidad de la máquina	CLBW 800	CLBW 1500
Reference number	52000813	52001012
ALT950	-	X
MLA-T 533-145 V+ - ST5	-	X
MLT 420-60 H	X	X
MLT 625-75 H	X	X
MLT 630-115	X	X
MLT 630-115 V	X	X
MLT 630-115 V CP	X	X
MLT 635-130 PS+	X	X
MLT 635-140 V+	X	X
MLT 730-115 V	X	X
MLT 730-115 V CP	X	X
MLT 733-115 LSU	X	X
MLT 737-130 PS+	X	X
MLT 741-130 PS+	X	X
MLT 741-140 V+	X	X
MLT 841-145 PS+	-	X
MLT 850-145 V+	-	X
MLT 940-140 V+	X	X
MLT 961-160 V+ L	-	X
MLT 1041-145 PS+L	X	X
MLFX 625-75 H	X	X
MLFX 732	X	X
MLFX 735 T LSU	X	X
MLFX 737-130 PS+	X	X
MLFX 741 T LSU	-	X
MLFX 841 - 145 PS+	-	X
MLFX 850-145 V+	-	X
MLFX 961-160 V+ L	-	X
MLFX 1035 LT LSU	-	X
MLFX 1041-145 PS+L	X	X
MLT 630-105 ST4 OLD	X	X
MLT 630-105 V CP ST4 OLD	X	X
MLT 630-105 V ST4 OLD	X	X
MLT 635-140 V+ ST4 OLD	X	X
MLT 730-115 V CP ST4 OLD	X	X
MLT 733-115 OLD	X	X
MLT 733-115 LSU ST4 OLD	X	X
MLT 733-115 ST4 OLD	X	X
MLT 737-130 PS+ ST4 OLD	X	X
MLT 741-140 V+ ST4 OLD	X	X
MLT 840-145 PS+ OLD	-	X
MLT 845-100 H OLD	-	X
MLT 845-120 OLD	-	X
MLT 940-140 V+ ST4 OLD	X	X
MLT 1040-145 PS+ L OLD	-	X
MLFX 737-130 PS+ OLD	X	X
MLFX 741-140 V+ S1 OLD	X	X
MLFX 840-140 PS+ OLD	-	X
MLFX 845-120 OLD	-	X
MLFX 845-120 H OLD	-	X
MLFX 961-145 V+ L OLD	-	X
MLFX 1040-140 PS+ L OLD	-	X

TABLA DE SÍMBOLOS

	No se requiere predisposición		Línea hidráulica		Retorno al depósito de aceite hidráulico
	Predisposición eléctrica		Predisposición de la plataforma		Predisposición manipulador de neumáticos, de cilindros

Wrapped Bale Clamp - Diagrama dimensional

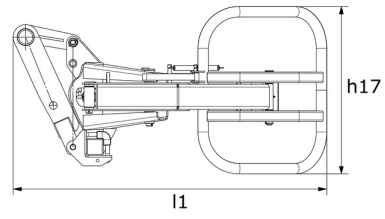
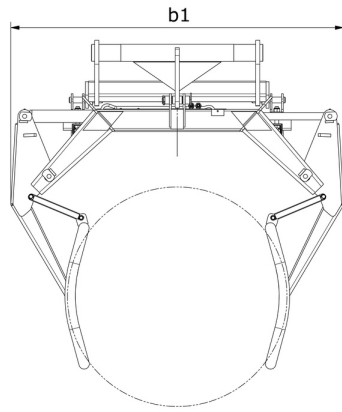



 **MANITOU**
HANDLING YOUR WORLD

Oficina Central

B.P. 249 - 430 rue de l'Aubinière

44150 Ancenis Cedex - Francia

Tel.: 00 33 (0)2 40 09 10 11 - Fax: 00 33 (0)2 40 09 10 97

www.manitou.com



Esta publicación describe las versiones y posibilidades de configuración de los productos Manitou que puedan diferir en equipamiento. Los equipamientos presentados en este folleto pueden ser de serie, opcionales o no estar disponibles en algunas versiones. Manitou se reserva el derecho, en cualquier momento y sin previo aviso, de modificar las especificaciones descritas y representadas. Las especificaciones aportadas no comprometen al fabricante. Para más información, póngase en contacto con su concesionario Manitou. Documento no contractual. Presentación de los productos no contractual. Lista de especificaciones no exhaustiva. Los logos y la identidad visual de la empresa son propiedad de Manitou y no pueden ser utilizados sin autorización. Todos los derechos reservados. Las fotos y los esquemas contenidos en este folleto se ofrecen para consulta y a título indicativo solamente.

Manitou BF SA - Sociedad anónima con Consejo de Administración - Capital social: 39 668 399 euros - 857 802 508 RCS Nantes