

Ficha técnica :

MANEJADOR DE SACAS



Características técnicas

- Max. total capacity of 4000 kg / 8820 lb with 4 loading points with 1000 kg / 2205 lb capacity each.
- 4 bag stoppers mounted on each loading point- limit the risk of bag falling.
- Anti-swing bag stabilizer, increases stability.

Beneficios para el cliente







- Increases efficiency & safety of big bag handling.
- Main structure made of tubes- limits the risk of bag damages & fall.
- Elevated structure- prevents any damage of trailer's roof while loading.
- Handles indifferently big bags with 1, 2 or 4 ears.

Características técnicas		HBB 1500 / 2400	HBB 2100 / 4000
Distancia al centro de gravedad (mm)		388	459
Capacidad			
Capacidad (kg)		2400	4000
Weight			
Peso (kg)		186	285
Peso y dimensión			
Altura total (mm)	h17	1322	1322
Longitud total (mm)	l1	1643	2181
Anchura sobre horquillas (mm)	b5	750	700
Anchura (mm)		1356	1356
Parámetros de trabajo			
Equipamiento de máquina		✕	✕

Compatibilidad de la máquina	HBB 1500 / 2400	HBB 2100 / 4000
Número de referencia	52781808	52691660
Referencia cargadora compacta	52578030	-
Enganche de 4 puntos	52742058	-
Acoplador tipo Euro	52742059	-
ALT950	X	-
MLA-T 533-145 V+ - ST5	X	-
MLT 420-60 H	X	-
MLT 625-75 H	X	-
MLT 625 e	X	-
MLT 630-115 (S1)	X	-
MLT 630-115 (S2)	X	-
MLT 630-115 V (S1)	X	-
MLT 630-115 V (S2)	X	-
MLT 630-115 V CP (S1)	X	-
MLT 630-115 V CP (S2)	X	-
MLT 635-130 PS+ (S1)	X	-
MLT 635-130 PS+ (S2)	X	-
MLT 635-140 V+ (S1)	X	-
MLT 635-140 V+ (S2)	X	-
MLT 730-115 V (S1)	X	-
MLT 730-115 V (S2)	X	-
MLT 730-115 V CP (S1)	X	-
MLT 730-115 V CP (S2)	X	-
MLT 733-115	X	-
MLT 733-115 (S2)	X	-
MLT 733-115 LSU (S1)	X	-
MLT 737-130 PS+ (S1)	X	-
MLT 738-130 PS+ (S1)	X	-
MLT 741-130 PS+ (S1)	X	-
MLT 742-130 PS+ (S1)	X	X
MLT 742-140 V+ (S1)	X	X
MLT 841-145 PS+	X	-
MLT 850-145 V+	X	X
MLT 937-115 (S1)	X	-
MLT 940-140 V+ (S1)	X	-
MLT 940-140 V+ (S2)	X	-
MLT 961-160 V+ L	X	X
MLT 1041-145 PS+L	X	-
MLFX 625-75 H	X	-
MLFX 732	X	-
MLFX 735 T LSU	X	-
MLFX 738-130 PS+ (S1)	X	-
MLFX 741 T LSU	X	-
MLFX 841 - 145 PS+	X	-
MLFX 850-145 V+	X	X
MLFX 961-160 V+ L	X	X
MLFX 1035 LT LSU	X	-
MLFX 1041-145 PS+L	X	-
MT 420 H	X	-
MT 625 e	X	-
MT 625 H	X	-
MT 625 H Comfort	X	-
MT 735 75D ST5	X	-
MT 935 75D ST5	X	-
MT 1135 75 D	X	-
MT 1135	X	-
MT 1135 H 100D	X	-
MT 1335 75D ST5	X	-
MT 1335 100D ST5	X	-
MT 1335 H 75D ST5	X	-
MT 1335 H 100D ST5	X	-
MT 1335 HA 75D ST5	X	-
MT 1335 HA 100D ST5	X	-
MT 1440	X	-
MT 1440 e	X	-

Compatibilidad de la máquina	HBB 1500 / 2400	HBB 2100 / 4000
MT 1840	X	-
MT 1840 e	X	-
MT-X 735	X	-
MT-X 1135	X	-
MT-X 1440	X	-
MT-X 1840	X	-
MXT 840 P	X	-
MXT 1740 P	X	-
ULM 412 H	X	-
ULM 415 H	X	-
MLT 630-105 ST4 OLD	X	-
MLT 630-105 V CP ST4 OLD	X	-
MLT 630-105 V ST4 OLD	X	-
MLT 635-130 PS+ ST4 OLD	X	-
MLT 635-140 V+ ST4 OLD	X	-
MLT 730-115 V CP ST4 OLD	X	-
MLT 730-115 V ST4 OLD	X	-
MLT 733-115 LSU ST4 OLD	X	-
MLT 733-115 ST4 OLD	X	-
MLT 737-130 PS+ ST4 OLD	X	-
MLT 741-140 V+ ST4 OLD	X	-
MLT 840-145 PS+ OLD	X	-
MLT 845-100 H OLD	X	-
MLT 845-120 OLD	X	-
MLT 940-140 V+ ST4 OLD	X	-
MLT 961-145 V+ L OLD	X	X
MLT 1040-145 PS+ L OLD	X	-
MLT-X 737-130 PS+ OLD	X	-
MLT-X 737-130 PS+ (S2) OLD	X	-
MLT-X 741-140 V+ S1 OLD	X	-
MLT-X 840-140 PS+ OLD	X	-
MLT-X 845-120 OLD	X	-
MLT-X 845-120 H OLD	X	-
MLT-X 961-145 V+ L OLD	X	X
MLT-X 1040-140 PS+ L OLD	X	-
MT 625 HA OLD	X	-
MT 733 Easy OLD	X	-
MT 933 Easy OLD	X	-
MT 1033 easy OLD	X	-
MT 1135 H easy ST5 OLD	X	-
MT 1135 ST5 OLD	X	-
MT 1335 OLD	X	-
MT 1335 ST5 OLD	X	-
MT 1440 A ST4 OLD	X	-
MT 1440 HA ST4 OLD	X	-
MT 1840 A STG4 OLD	X	-
MT 1840 HA ST4 OLD	X	-
MT-X 733 OLD	X	-
MT-X 1033 OLD	X	-
MT-X 1440 A OLD	X	-
MT-X 1840 A OLD	X	-
Número de referencia E-RECO	931627	-
MRT 1645 75	X	-
MRT 1645 115	X	-
MRT 1845 75	X	-
MRT 1845 115	X	-
MRT 2145 115	X	-
MRT 2260	X	-
MRT 2260 e	X	-
MRT 2545 115	X	-
MRT 2570	X	-
MRT 2660	X	-
MRT 2660 e	X	-
MRT 3060	X	-
MRT 3570	X	-
MRT 3570 ES	X	-
MRT-X 1645	X	-
MRT-X 1845	X	-
MRT-X 2145	X	-
MRT-X 2260	X	-
MRT-X 2545	X	-
MRT-X 2570	X	-
MRT-X 2660	X	-
MRT-X 3060	X	-
MRT-X 3570	X	-
MRT-X 3570 ES	X	-
MRT 1640 Easy T4 S2 360° OLD	X	-
MRT 1640 Easy T4 S2 400° OLD	X	-
MRT 1840 Easy T4 S2 360° OLD	X	-
MRT 1840 Easy T4 S2 400° OLD	X	-

Compatibilidad de la máquina	HBB 1600 / 2400	HBB 2100 / 4000
MRT 2145 Easy T4 S2 360° OLD	X	-
MRT 2145 Easy T4 S2 400° OLD	X	-
MRT 2470 Privilege Plus OLD	X	-
MRT 2545 Easy T4 S2 360° OLD	X	-
MRT 2545 Easy T4 S2 400° OLD	X	-
MRT 3050 Privilege Plus OLD	X	-
MRT 3255 Privilege Plus OLD	X	-
MRT-X 2470 Privilege Plus OLD	X	-
MRT-X 3050 Privilege Plus OLD	X	-
MRT-X 3255 Privilege Plus OLD	X	-

TABLA DE SÍMBOLOS					
	No se requiere predisposición		Línea hidráulica		Retorno al depósito de aceite hidráulico
	Predisposición eléctrica		Predisposición de la plataforma		Predisposición manipulador de neumáticos, de cilindros

Manejador de sacas - Diagrama dimensional

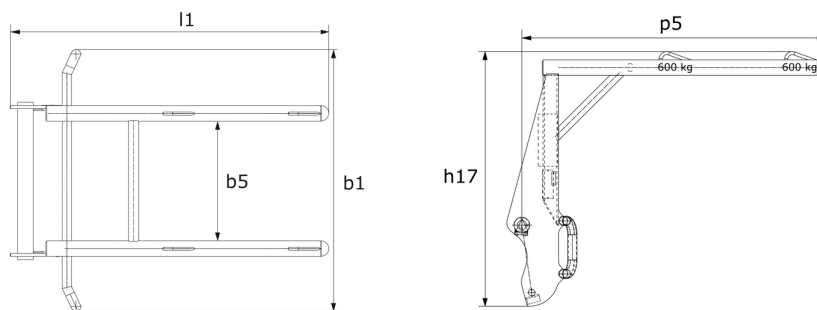



Oficina Central

B.P. 249 - 430 rue de l'Aubinière

44150 Ancenis Cedex - Francia

Tel.: 00 33 (0)2 40 09 10 11 - Fax: 00 33 (0)2 40 09 10 97

www.manitou.com



Esta publicación describe las versiones y posibilidades de configuración de los productos Manitou que puedan diferir en equipamiento. Los equipamientos presentados en este folleto pueden ser de serie, opcionales o no estar disponibles en algunas versiones. Manitou se reserva el derecho, en cualquier momento y sin previo aviso, de modificar las especificaciones descritas y representadas. Las especificaciones aportadas no comprometen al fabricante. Para más información, póngase en contacto con su concesionario Manitou. Documento no contractual. Presentación de los productos no contractual. Lista de especificaciones no exhaustiva. Los logos y la identidad visual de la empresa son propiedad de Manitou y no pueden ser utilizados sin autorización. Todos los derechos reservados. Las fotos y los esquemas contenidos en este folleto se ofrecen para consulta y a título indicativo solamente.

Manitou BF SA - Sociedad anónima con Consejo de Administración - Capital social: 39 668 399 euros - 857 802 508 RCS Nantes