

Ficha técnica :

# BIG BAG HANDLER



## Customer benefits

- Increases efficiency & safety of big bag handling.
- Main structure made of tubes- limits the risk of bag damages & fall.
- Elevated structure- prevents any damage of trailer's roof while loading.
- Handles indifferently big bags with 1, 2 or 4 ears.



## Technical characteristics



- Max. total capacity of 4000 kg / 8820 lb with 4 loading points with 1000 kg / 2205 lb capacity each.
- 4 bag stoppers mounted on each loading point- limit the risk of bag falling.
- Anti-swing bag stabilizer, increases stability.

Technical characteristics		HBB 1500 / 2400	HBB 2100 / 4000
Distance to center of gravity (mm)		388	459
Capacities			
Capacity (kg)		2400	4000
Weight			
Overall weight (kg)		186	285
Weight and dimensions			
Overall height (mm)	h17	1322	1322
Overall length (mm)	l1	1643	2181
Fork spread (mm)	b5	750	700
Width (mm)		1356	1356
Working Parameters			
Machine Equipment		✕	✕

Compatibilidad de la máquina	HBB 1500 / 2400	HBB 2100 / 4000
Reference number	52781808	52691660
Skid Steer Camiage reference	52578030	-
4 point Camiage	52742058	-
Euro Camiage	52742059	-
ALT950	X	-
GCT 3-14	X	-
GCT 3-14 +	X	-
MLA-T 533-145 V+ - ST5	X	-
MLT 420-60 H	X	-
MLT 625-75 H	X	-
MLT 630-115	X	-
MLT 630-115 V	X	-
MLT 630-115 V CP	X	-
MLT 635-130 PS+	X	-
MLT 635-140 V+	X	-
MLT 730-115 V	X	-
MLT 730-115 V CP	X	-
MLT 733-115 LSU	X	-
MLT 737-130 PS+	X	-
MLT 741-130 PS+	X	-
MLT 841-145 PS+	X	-
MLT 850-145 V+	X	X
MLT 940-140 V+	X	-
MLT 961-160 V+ L	X	X
MLT 1041-145 PS+L	X	-
MLFX 625-75 H	X	-
MLFX 732	X	-
MLFX 735 T LSU	X	-
MLFX 737-130 PS+	X	-
MLFX 741 T LSU	X	-
MLFX 841 - 145 PS+	X	-
MLFX 850-145 V+	X	X
MLFX 961-160 V+ L	X	X
MLFX 1035 LT LSU	X	-
MLFX 1041-145 PS+L	X	-
MT 420 H	X	-
MT 625 H	X	-
MT 625 H Comfort	X	-
MT 625 HA	X	-
MT 735 75D ST5	X	-
MT 935 75D ST5	X	-
MT 1135 75 D	X	-
MT 1135 H 100D	X	-
MT 1335 75D ST5	X	-
MT 1335 100D ST5	X	-
MT 1335 H 75D ST5	X	-
MT 1335 H 100D ST5	X	-
MTFX 733	X	-
MTFX 1033	X	-
MTFX 1440	X	-
MTFX 1440 A	X	-
MTFX 1840	X	-
MTFX 1840 A	X	-
MXT 840 K	X	-
MXT 840 P	X	-
MXT 1740 K	X	-
MXT 1740 P	X	-
ULM 412 H	X	-
ULM 412 H	X	-
ULM 415 H	X	-
ULM 415 H	X	-
MLT 630-105 ST4 <b>OLD</b>	X	-
MLT 630-105 V CP-ST4 <b>OLD</b>	X	-
MLT 630-105 V ST4 <b>OLD</b>	X	-
MLT 635-130 PS+ ST4 <b>OLD</b>	X	-

Compatibilidad de la máquina	HBB 1500 / 2400	HBB 2100 / 4000
MLT 635-140 V+ ST4 <b>OLD</b>	X	-
MLT 730-115 V CP ST4 <b>OLD</b>	X	-
MLT 730-115 V ST4 <b>OLD</b>	X	-
MLT 733-115 <b>OLD</b>	X	-
MLT 733-115 LSU ST4 <b>OLD</b>	X	-
MLT 733-115 ST4 <b>OLD</b>	X	-
MLT 737-130 PS+ ST4 <b>OLD</b>	X	-
MLT 741-140 V+ ST4 <b>OLD</b>	X	-
MLT 840-145 PS+ <b>OLD</b>	X	-
MLT 845-100 H <b>OLD</b>	X	-
MLT 845-120 <b>OLD</b>	X	-
MLT 940-140 V+ ST4 <b>OLD</b>	X	-
MLT 961-145 V+ L <b>OLD</b>	X	X
MLT 1040-145 PS+ L <b>OLD</b>	X	-
MLT-X 737-130 PS+ <b>OLD</b>	X	-
MLT-X 741-140 V+ S1 <b>OLD</b>	X	-
MLT-X 840-140 PS+ <b>OLD</b>	X	-
MLT-X 845-120 <b>OLD</b>	X	-
MLT-X 845-120 H <b>OLD</b>	X	-
MLT-X 961-145 V+ L <b>OLD</b>	X	X
MLT-X 1040-140 PS+ L <b>OLD</b>	X	-
MT 733 Easy <b>OLD</b>	X	-
MT 933 Easy <b>OLD</b>	X	-
MT 1033 easy <b>OLD</b>	X	-
MT 1135 <b>OLD</b>	X	-
MT 1135 H easy ST5 <b>OLD</b>	X	-
MT 1135 ST5 <b>OLD</b>	X	-
MT 1335 <b>OLD</b>	X	-
MT 1335 ST5 <b>OLD</b>	X	-
MT 1440 <b>OLD</b>	X	-
MT 1440 A <b>OLD</b>	X	-
MT 1440 HA <b>OLD</b>	X	-
MT 1840 <b>OLD</b>	X	-
MT 1840 A <b>OLD</b>	X	-
MT 1840 HA <b>OLD</b>	X	-
<b>Reference number E-RECO</b>	<b>931627</b>	-
MRT 1645 75	X	-
MRT 1645 115	X	-
MRT 1845 75	X	-
MRT 1845 115	X	-
MRT 2145 115	X	-
MRT 2260	X	-
MRT 2260 e	X	-
MRT 2545 115	X	-
MRT 2570	X	-
MRT 2660	X	-
MRT 2660 e	X	-
MRT 3060	X	-
MRT 3570	X	-
MRT 3570 ES	X	-
MRT-X 1645	X	-
MRT-X 1845	X	-
MRT-X 2145	X	-
MRT-X 2260	X	-
MRT-X 2545	X	-
MRT-X 2570	X	-
MRT-X 2660	X	-
MRT-X 3060	X	-
MRT-X 3570	X	-
MRT-X 3570 ES	X	-
MRT 1640 Easy T4 S2 360° <b>OLD</b>	X	-
MRT 1640 Easy T4 S2 400° <b>OLD</b>	X	-
MRT 1840 Easy T4 S2 360° <b>OLD</b>	X	-
MRT 1840 Easy T4 S2 400° <b>OLD</b>	X	-
MRT 2145 Easy T4 S2 360° <b>OLD</b>	X	-
MRT 2145 Easy T4 S2 400° <b>OLD</b>	X	-
MRT 2470 Privilege Plus <b>OLD</b>	X	-
MRT 2545 Easy T4 S2 360° <b>OLD</b>	X	-
MRT 2545 Easy T4 S2 400° <b>OLD</b>	X	-
MRT 3050 Privilege Plus <b>OLD</b>	X	-
MRT 3255 Privilege Plus <b>OLD</b>	X	-
MRT-X 2470 Privilege Plus <b>OLD</b>	X	-
MRT-X 3050 Privilege Plus <b>OLD</b>	X	-
MRT-X 3255 Privilege Plus <b>OLD</b>	X	-

TABLA DE SÍMBOLOS					
	No se requiere predisposición		Línea hidráulica		Retorno al depósito de aceite hidráulico

	Predisposición eléctrica		Predisposición de la plataforma		Predisposición manipulador de neumáticos, de cilindros
--	--------------------------	--	---------------------------------	--	--

## Big Bag Handler - Diagrama dimensional

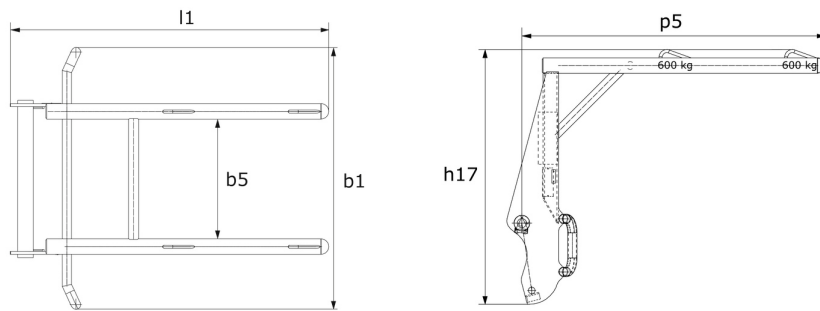



 **MANITOU**  
**HANDLING YOUR WORLD**

**Oficina Central**

B.P. 249 - 430 rue de l'Aubinière

44150 Ancenis Cedex - Francia

Tel.: 00 33 (0)2 40 09 10 11 - Fax: 00 33 (0)2 40 09 10 97

[www.manitou.com](http://www.manitou.com)



Esta publicación describe las versiones y posibilidades de configuración de los productos Manitou que puedan diferir en equipamiento. Los equipamientos presentados en este folleto pueden ser de serie, opcionales o no estar disponibles en algunas versiones. Manitou se reserva el derecho, en cualquier momento y sin previo aviso, de modificar las especificaciones descritas y representadas. Las especificaciones aportadas no comprometen al fabricante. Para más información, póngase en contacto con su concesionario Manitou. Documento no contractual. Presentación de los productos no contractual. Lista de especificaciones no exhaustiva. Los logos y la identidad visual de la empresa son propiedad de Manitou y no pueden ser utilizados sin autorización. Todos los derechos reservados. Las fotos y los esquemas contenidos en este folleto se ofrecen para consulta y a título indicativo solamente.

Manitou BF SA - Sociedad anónima con Consejo de Administración - Capital social: 39 668 399 euros - 857 802 508 RCS Nantes