

Technical sheet :

# ***SHEAR BUCKETS***

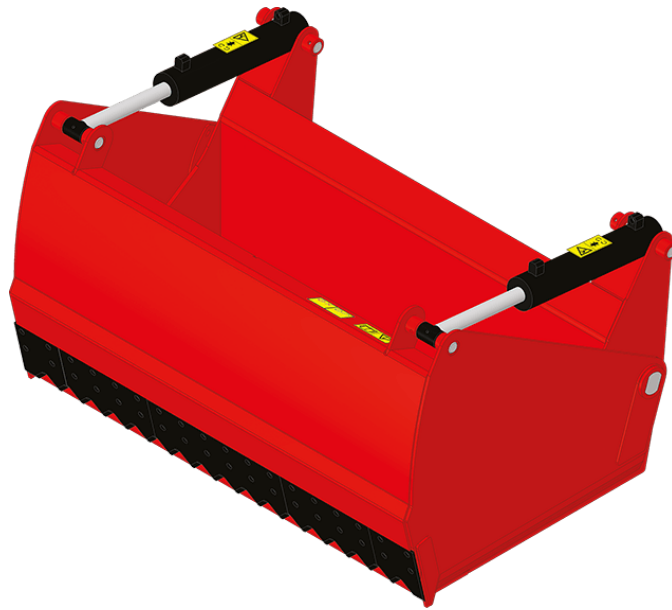



## **Customer benefits**





- Suitable for any type of silage.
- Clean silage pit face, limits secondary fermentation.
- Powerful attachment for a fast cutting.
- Open back for more visibility.
- Bucket-type bottom, ideal for the handling of mineral feed & other materials.

## **Technical characteristics**

- Boxed structure, rigidity & longevity.
- Body made of high resistance steels.
- Heavy duty teeth for easy penetration.
- Lateral shears for a good pit penetration & clean cutting.
- Increased cylinder diameter for more power.
- 500 HB welded cutting edge.

Technical characteristics		SHB 2200 / 1650	SHB 2400 / 1800
Distance to center of gravity (mm)		522	522
Capacities			
Capacity (kg)		1650	1800
Heaped capacity (l)		1650	1800
Weight			
Overall weight (kg)		892	1080
Weight and dimensions			
Overall height (mm)	h17	1010	1010
Overall length (mm)	l1	1295	1295
Width (mm)		2254	2454
Opened grapple height (mm)	h34	1475	1475
Depth (mm)	p5	850	850
Working Parameters			
Machine Equipment			
Other Data for Attachments			
Wear plate hardness		500	500

Machines compatibility	SHB 2200 / 1650	SHB 2400 / 1800
Reference number	52000386	52000387
ALT950	X	-
MLA-T 533-145 V+ - ST5	X	-
MLT 635-130 PS+	X	-
MLT 635-140 V+	X	-
MLT 733-115 LSU	-	X
MLT 737-130 PS+	-	X
MLT 741-130 PS+	-	X
MLT 741-140 V+	-	X
MLT 841-145 PS+	-	X
MLT 850-145 V+	-	X
MLT 937-115	-	X
MLT 940-140 V+	-	X
MLT 1041-145 PS+L	-	X
MLFX 732	X	-
MLFX 735 T LSU	X	-
MLFX 735 T LSU (70 KW)	X	-
MLFX 737-130 PS+	-	X
MLFX 741 T LSU	X	X
MLFX 841 - 145 PS+	-	X
MLFX 850-145 V+	-	X
MLFX 1041-145 PS+L	-	X
MLT 635-130 PS+ ST4 <b>OLD</b>	X	-
MLT 635-140 V+ ST4 <b>OLD</b>	X	-
MLT 733-115 <b>OLD</b>	-	X
MLT 733-115 ST4 <b>OLD</b>	-	X
MLT 737-130 PS+ ST4 <b>OLD</b>	-	X
MLT 741-140 V+ ST4 <b>OLD</b>	-	X
MLT 840-145 PS+ <b>OLD</b>	-	X
MLT 940-140 V+ ST4 <b>OLD</b>	-	X
MLT 1040-145 PS+ L <b>OLD</b>	-	X
MLFX 737-130 PS+ <b>OLD</b>	-	X
MLFX 741-140 V+ S1 <b>OLD</b>	-	X
MLFX 840-140 PS+ <b>OLD</b>	-	X
MLFX 1040-140 PS+ L <b>OLD</b>	-	X

TABLE SYMBOL					
	No predisposition required		Hydraulic line		Return piping to hydraulic oil tank
	Electric predisposition		Platform predisposition		Tyre handler, cylinder handler predisposition

# Shear buckets - Dimensional drawing

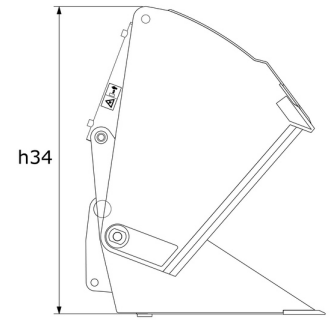



**Head Office**

B.P. 249 - 430 rue de l'Aubinière

44150 Ancenis Cedex - France

Tel: +33 (0)2 40 09 10 11 - Fax: +33 (0)2 40 09 10 97

[www.manitou.com](http://www.manitou.com)



This publication provides a description of the configuration versions and options for Manitou products, which may differ for equipment. The equipment presented in this brochure may be part of a series, as an option, or it may not be available, depending on the versions. Manitou reserves the right, at any time and without notice, to amend the specifications described and represented. The specifications provided do not bind the manufacturer. For more details, please contact your Manitou agent. This is not a contractually binding document. The presentation of the products is not contractually binding. List of specifications non-exhaustive. The logos as well as the visual identity of the company are owned by Manitou and cannot be used without authorisation. All rights reserved. The photos and diagrams contained in this brochure are only provided for consultation and information purposes.

MANITOU BF SA - Limited company with board of directors - Share capital: 39,668,399 euros - 857 802 508 RCS Nantes