

Ficha técnica :

# ***SHEAR BUCKETS***





## **Customer benefits**

- Suitable for any type of silage.
- Clean silage pit face, limits secondary fermentation.
- Powerful attachment for a fast cutting.
- Open back for more visibility.
- Bucket-type bottom, ideal for the handling of mineral feed & other materials.







## **Technical characteristics**

- Boxed structure, rigidity & longevity.
- Body made of high resistance steels.
- Heavy duty teeth for easy penetration.
- Lateral shears for a good pit penetration & clean cutting.
- Increased cylinder diameter for more power.
- 500 HB welded cutting edge.

Technical characteristics		SHB 2200 / 1650	SHB 2400 / 1800
Distance to center of gravity (mm)		522	522
Capacities			
Capacity (kg)		1650	1800
Heaped capacity (l)		1650	1800
Weight			
Overall weight (kg)		892	1080
Weight and dimensions			
Overall height (mm)	h17	1010	1010
Overall length (mm)	l1	1295	1295
Width (mm)		2254	2454
Opened grab height (mm)	h34	1475	1475
Depth (mm)	p5	850	850
Working Parameters			
Machine Equipment			
Other Data for Attachments			
Wear plate hardness		500	500

Compatibilidad de la máquina	SHB 2200 / 1650	SHB 2400 / 1800
Reference number	52000386	52000387
ALT950	X	-
MLA-T 533-145 V+ - ST5	X	-
MLT 635-130 PS+	X	-
MLT 635-140 V+	X	-
MLT 733-115 LSU	-	X
MLT 737-130 PS+	-	X
MLT 741-130 PS+	-	X
MLT 741-140 V+	-	X
MLT 841-145 PS+	-	X
MLT 850-145 V+	-	X
MLT 940-140 V+	-	X
MLT 1041-145 PS+L	-	X
MLFX 732	X	-
MLFX 735 T LSU	X	-
MLFX 735 T LSU (70 KW)	X	-
MLFX 737-130 PS+	-	X
MLFX 741 T LSU	X	X
MLFX 841 - 145 PS+	-	X
MLFX 850-145 V+	-	X
MLFX 1041-145 PS+L	-	X
MLT 635-130 PS+ ST4 <b>OLD</b>	X	-
MLT 635-140 V+ ST4 <b>OLD</b>	X	-
MLT 733-115 <b>OLD</b>	-	X
MLT 733-115 ST4 <b>OLD</b>	-	X
MLT 737-130 PS+ ST4 <b>OLD</b>	-	X
MLT 741-140 V+ ST4 <b>OLD</b>	-	X
MLT 840-145 PS+ <b>OLD</b>	-	X
MLT 940-140 V+ ST4 <b>OLD</b>	-	X
MLT 1040-145 PS+ L <b>OLD</b>	-	X
MLTX 737-130 PS+ <b>OLD</b>	-	X
MLTX 741-140 V+ S1 <b>OLD</b>	-	X
MLTX 840-140 PS+ <b>OLD</b>	-	X
MLTX 1040-140 PS+ L <b>OLD</b>	-	X

**TABLA DE SÍMBOLOS**

	No se requiere predisposición		Línea hidráulica		Retorno al depósito de aceite hidráulico
	Predisposición eléctrica		Predisposición de la plataforma		Predisposición manipulador de neumáticos, de cilindros

## Shear buckets - Diagrama dimensional

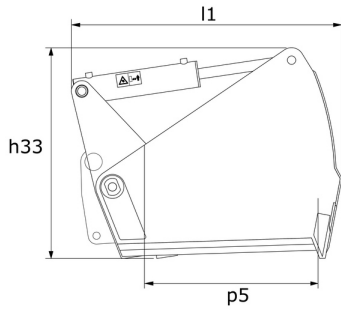



 **MANITOU**  
**HANDLING YOUR WORLD**

**Oficina Central**

B.P. 249 - 430 rue de l'Aubinière

44150 Ancenis Cedex - Francia

Tel.: 00 33 (0)2 40 09 10 11 - Fax: 00 33 (0)2 40 09 10 97

[www.manitou.com](http://www.manitou.com)



Esta publicación describe las versiones y posibilidades de configuración de los productos Manitou que puedan diferir en equipamiento. Los equipamientos presentados en este folleto pueden ser de serie, opcionales o no estar disponibles en algunas versiones. Manitou se reserva el derecho, en cualquier momento y sin previo aviso, de modificar las especificaciones descritas y representadas. Las especificaciones aportadas no comprometen al fabricante. Para más información, póngase en contacto con su concesionario Manitou. Documento no contractual. Presentación de los productos no contractual. Lista de especificaciones no exhaustiva. Los logos y la identidad visual de la empresa son propiedad de Manitou y no pueden ser utilizados sin autorización. Todos los derechos reservados. Las fotos y los esquemas contenidos en este folleto se ofrecen para consulta y a título indicativo solamente.

Manitou BF SA - Sociedad anónima con Consejo de Administración - Capital social: 39 668 399 euros - 857 802 508 RCS Nantes