

Technical sheet :

ROUND BALE CLAMP (COMPACT MACHINES)

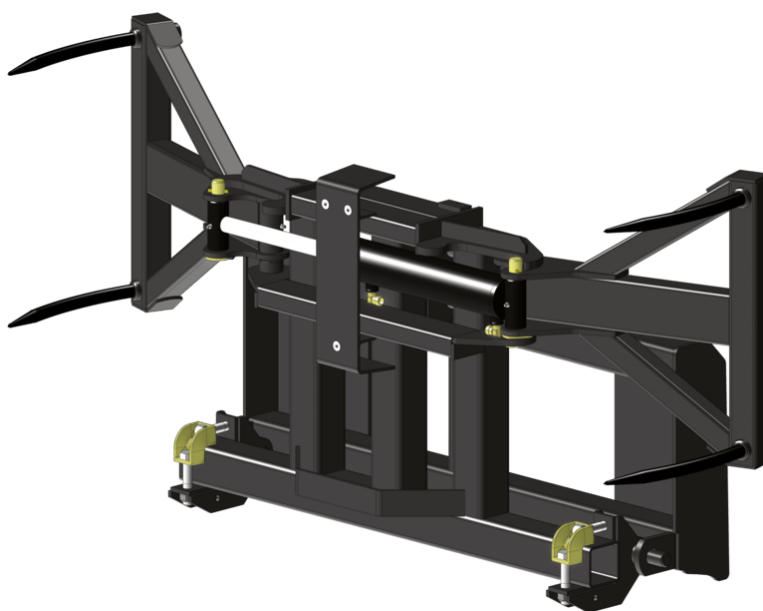

Customer benefits

- Attachment designed for the handling of round bales.
- Allows an easy and clean handling







Technical characteristics

- Can be used for square bales.
- Synchronized arms with 4 forged teeth each.

MANITOU
GROUP ATTACHMENTS

Technical characteristics		CLBR 2x2 / 800	
Distance to center of gravity (in)		1' 1"	
Capacities			
Capacity (lb)		1763.70	
Weight			
Overall weight (lb)		330.69	
Weight and dimensions			
Overall height (in)	h17	2' 10"	
Overall length (in)	l1	3'	
Width (in)		3' 7"	
Working Parameters			
Machine Equipment			
Teeth / Fingers		2 / 2	
Opening minimum (in)		2' 7"	
Opening maximum (in)		5' 2"	
Fork spread minimum (in)	b5	6'	

Machines compatibility		CLBR 2x2 / 800	
All-Tach® Narrow		N51502696	
All-Tach®		N51502631	
4 point Carriage		N51502632	
Euro Carriage		N51502633	
AL420		X	
AL430		X	
AL530		X	
AL550		X	
AL650		X	
AL750		X	
GCT 3-14		X	
GCT 3-14 +		X	
MLA 4-50 H		X	
MLA 4-50 H-C		X	
MLA 5-50 H		X	
MLA 5-60 H-Z		X	
MLA 6-65 H-Z		X	
MLA 7-75 H-Z		X	
ULM 412 H		X	
ULM 412 H		X	
ULM 415 H		X	
ULM 415 H		X	
MLA 1-25 H OLD		X	
MLA 3-35 H OLD		X	

TABLE SYMBOL					
	No predisposition required		Hydraulic line		Return piping to hydraulic oil tank
	Electric predisposition		Platform predisposition		Tyre handler, cylinder handler predisposition



Head Office

B.P. 249 - 430 rue de l'Aubinière

44150 Ancenis Cedex - France

Tel: +33 (0)2 40 09 10 11 - Fax: +33 (0)2 40 09 10 97

www.manitou.com



This publication provides a description of the configuration versions and options for Manitou products, which may differ for equipment. The equipment presented in this brochure may be part of a series, as an option, or it may not be available, depending on the versions. Manitou reserves the right, at any time and without notice, to amend the specifications described and represented. The specifications provided do not bind the manufacturer. For more details, please contact your Manitou agent. This is not a contractually binding document. The presentation of the products is not contractually binding. List of specifications non-exhaustive. The logos as well as the visual identity of the company are owned by Manitou and cannot be used without authorisation. All rights reserved. The photos and diagrams contained in this brochure are only provided for consultation and information purposes.

MANITOU BF SA - Limited company with board of directors - Share capital: 39,668,399 euros - 857 802 508 RCS Nantes