

SQUARE WRAPPED BALE CLAMP (COMPACT MACHINES)

CLAMPS

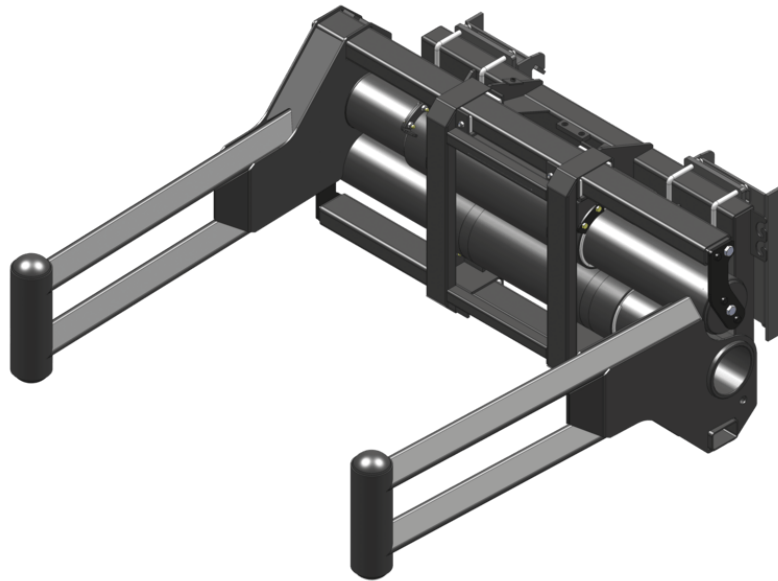

GEHL®

Customer benefits

- Tubular structure- no risk of damaging the film when moving wrapped bales.
- Wide clamp opening for big or multiple bale handling.
- Superior component protection.
- Multi-task: designed for wrapped square bales, can also handle standard square bales or round bales.







Technical characteristics

- Strong frame & components for intensive applications.
- Telescopic cinematics-smooth movement & strong clamping capacity.
- Massive use of Teflon® pad.
- Limited maintenance.
- Standard pressure limiter.

MANITOU GROUP ATTACHMENTS

Capacities		CLBSW 2000 / 1000
Capacity (kg)		1000
Weight		
Overall weight (kg)		477
Weight and dimensions		
Overall height (mm)	h17	679
Arm length (mm)		1811
Working Parameters		
Machine Equipment		
Opening minimum (mm)		740
Opening maximum (mm)		2090

Machines compatibility		CLBSW 2000 / 1000
All-Tach®		NS1502694
4 point Carriage		NS1502693
Euro Carriage		NS1502692
AL650		X
AL750		X
ALT750		X
MLA 6-65 H-Z		X
MLA-T 516-75 H		X
ALT750 OLD		X
ALT750 OLD		X

TABLE SYMBOL					
	No predisposition required		Hydraulic line		Return piping to hydraulic oil tank
	Electric predisposition		Platform predisposition		Tyre handler, cylinder handler predisposition



GEHL®

Siège Social
P.O. Box 179 - One Gehl Way - West Bend, WI, USA 53095
Tel: (262) 334-9461 - Fax: (262) 338-7517
www.gehl.com



This brochure describes versions and configuration options for Gehl products which may be fitted with different equipment. The equipment described in this brochure may be standard, optional or not available depending on version. Gehl reserves the right to change the specifications shown and described at any time and without prior warning. The manufacturer is not liable for the specifications given. For more information, contact your Gehl dealer. Non-contractual document. Product descriptions may differ from actual products. List of specifications is not comprehensive. The logos and visual identity of the company are the property of Gehl and may not be used without authorization. All rights reserved. The photos and diagrams contained in this brochure are provided for information only.

MANITOU EQUIPMENT AMERICAS, LLC - Limited company with board of directors - Share capital: 39,668,399 euros - 857 802 508 RCS West Bend