

Technical sheet :

SQUARE WRAPPED BALE CLAMP (COMPACT MACHINES)

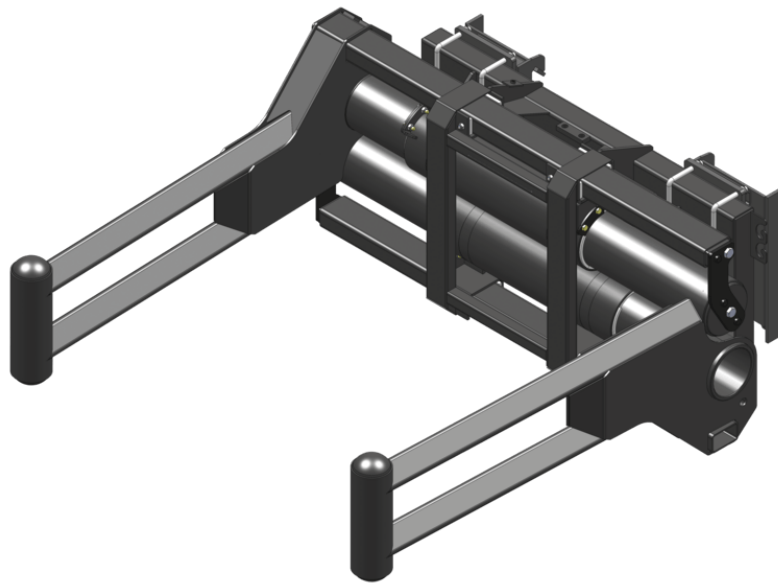

Customer benefits







- Tubular structure- no risk of damaging the film when moving wrapped bales.
- Wide clamp opening for big or multiple bale handling.
- Superior component protection.
- Multi-task: designed for wrapped square bales, can also handle standard square bales or round bales.

Technical characteristics

- Strong frame & components for intensive applications.
- Telescopic cinematics-smooth movement & strong clamping capacity.
- Massive use of Teflon® pad.
- Limited maintenance.
- Standard pressure limiter.

Capacities		CLBSW 2000 / 1000
Capacity (kg)		1000
Weight		
Overall weight (kg)		477
Weight and dimensions		
Overall height (mm)	h17	679
Arm length (mm)		1811
Working Parameters		
Required machine equipment		
Minimum opening (mm)		740
Maximum opening (mm)		2090

Machines compatibility		CLBSW 2000 / 1000
All-Tach®		N51502694
4 point Carriage		N51502693
Euro Carriage		N51502692
AL650		X
AL750		X
ALT750		X
MLA 6-65 H-Z		X
MLA-T 516-75 H		X
ALT750 OLD		X
ALT750 OLD		X

TABLE SYMBOL					
	No predisposition required		Hydraulic line		Return piping to hydraulic oil tank
	Electric predisposition		Platform predisposition		Tyre handler, cylinder handler predisposition



Head Office

B.P. 249 - 430 rue de l'Aubinière

44150 Ancenis Cedex - France

Tel: +33 (0)2 40 09 10 11 - Fax: +33 (0)2 40 09 10 97

www.manitou.com



This publication provides a description of the configuration versions and options for Manitou products, which may differ for equipment. The equipment presented in this brochure may be part of a series, as an option, or it may not be available, depending on the versions. Manitou reserves the right, at any time and without notice, to amend the specifications described and represented. The specifications provided do not bind the manufacturer. For more details, please contact your Manitou agent. This is not a contractually binding document. The presentation of the products is not contractually binding. List of specifications non-exhaustive. The logos as well as the visual identity of the company are owned by Manitou and cannot be used without authorisation. All rights reserved. The photos and diagrams contained in this brochure are only provided for consultation and information purposes.

MANITOU BF SA - Limited company with board of directors - Share capital: 39,668,399 euros - 857 802 508 RCS Nantes