

Ficha técnica :

PINZA PARA BALAS CUADRADAS ENVUELTAS (MAQUINAS COMPACTAS)

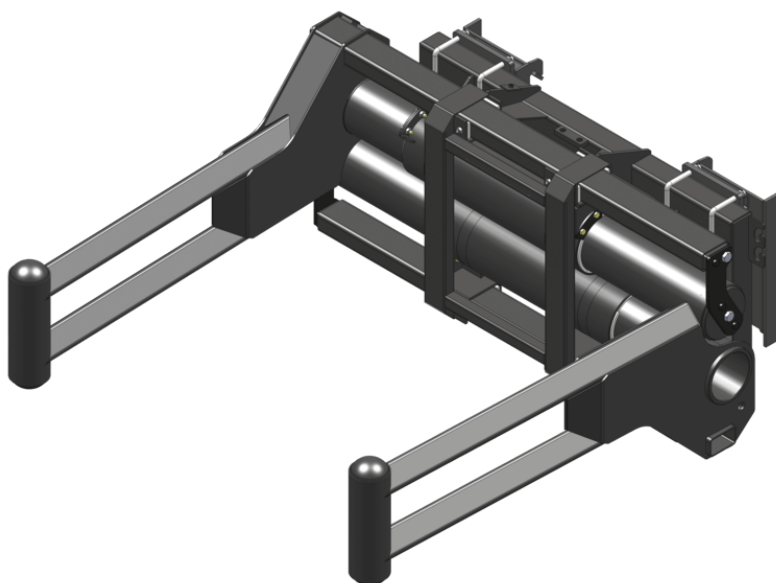

Beneficios para el cliente







- Tubular structure- no risk of damaging the film when moving wrapped bales.
- Wide clamp opening for big or multiple bale handling.
- Superior component protection.
- Multi-task: designed for wrapped square bales, can also handle standard square bales or round bales.

Características técnicas

- Strong frame & components for intensive applications.
- Telescopic cinematics-smooth movement & strong clamping capacity.
- Massive use of Teflon® pad.
- Limited maintenance.
- Standard pressure limiter.

Capacidad		CLBSW 2000 / 1000
Capacidad (kg)		1000
Weight		
Peso (kg)		477
Peso y dimensión		
Altura total (mm)	h17	679
Largo de brazo (mm)		1811
Parámetros de trabajo		
Equipamiento de máquina		
Apertura mínima (mm)		740
Apertura máxima (mm)		2090

Compatibilidad de la máquina		CLBSW 2000 / 1000
All-Tach®		N51502694
Eganche de 4 puntos		N51502693
Acoplador tipo Euro		N51502692
AL650		X
AL750		X
ALT750		X
MLA 6-65 H-Z		X
MLA-T 516-75 H		X
ALT750 OLD		X
ALT750 OLD		X

TABLA DE SÍMBOLOS					
	No se requiere predisposición		Línea hidráulica		Retorno al depósito de aceite hidráulico
	Predisposición eléctrica		Predisposición de la plataforma		Predisposición manipulador de neumáticos, de cilindros



Oficina Central

B.P. 249 - 430 rue de l'Aubinière

44150 Ancenis Cedex - Francia

Tel.: 00 33 (0)2 40 09 10 11 - Fax: 00 33 (0)2 40 09 10 97

www.manitou.com



Esta publicación describe las versiones y posibilidades de configuración de los productos Manitou que puedan diferir en equipamiento. Los equipamientos presentados en este folleto pueden ser de serie, opcionales o no estar disponibles en algunas versiones. Manitou se reserva el derecho, en cualquier momento y sin previo aviso, de modificar las especificaciones descritas y representadas. Las especificaciones aportadas no comprometen al fabricante. Para más información, póngase en contacto con su concesionario Manitou. Documento no contractual. Presentación de los productos no contractual. Lista de especificaciones no exhaustiva. Los logos y la identidad visual de la empresa son propiedad de Manitou y no pueden ser utilizados sin autorización. Todos los derechos reservados. Las fotos y los esquemas contenidos en este folleto se ofrecen para consulta y a título indicativo solamente.

Manitou BF SA - Sociedad anónima con Consejo de Administración - Capital social: 39 668 399 euros - 857 802 508 RCS Nantes