

Fiche technique :

PINCE A BALLEES CARREES ENRUBANNEES (MACHINES COMPACTES)

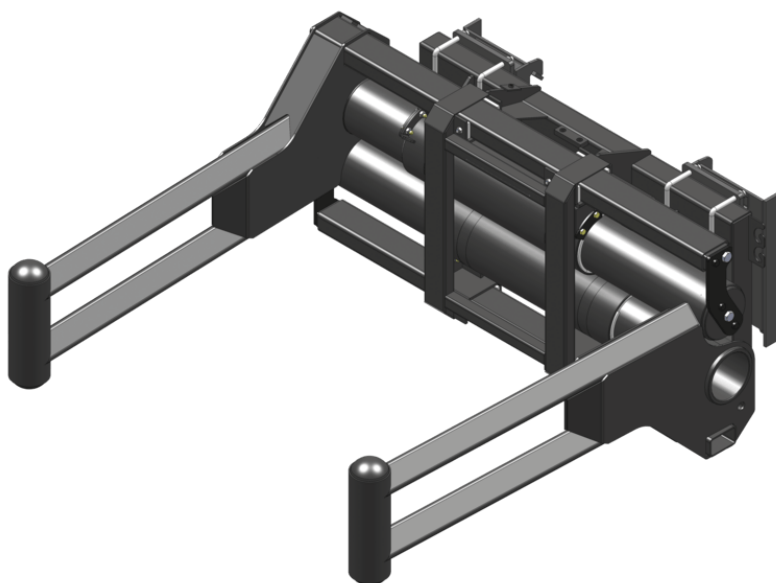

Bénéfices client







- Structure tubulaire, aucun risque d'endommager le film lors du déplacement des balles enveloppées.
- Large ouverture de la pince pour la manipulation de grosses ou multiples balles.
- Protection supérieure des composants.
- Multi-tâches : conçu pour les balles carrées enveloppées, peut également manipuler des balles carrées standard ou des balles rondes.

Caractéristiques techniques

- Cadre et composants solides pour des applications intensives.
- Cinématique télescopique - mouvement fluide et forte capacité de serrage.
- Utilisation massive de Téflon®.
- Entretien limité.
- Limiteur de pression standard.

Capacités		CLBSW 2000 / 1000
Capacité nominale (kg)		1000
Poids		
Poids (kg)		477
Poids et dimensions		
Hauteur hors tout (mm)	h17	679
Longueur du bras (mm)		1811
Paramètres de travail		
Équipement Machine		
Ouverture minimum (mm)		740
Ouverture maximum (mm)		2090

Compatibilité machine		CLBSW 2000 / 1000
All-Tach®		N51502694
Tablier 4 points		N51502693
Tablier Euro		N51502692
AL650		X
AL750		X
ALT750		X
MLA 6-65 H-Z		X
MLA-T 516-75 H		X
ALT750 OLD		X
ALT750 OLD		X

TABLEAU DES SYMBOLES					
	Aucune prédisposition requise		Ligne hydraulique en tête de flèche		Retour hydraulique au réservoir
	Prédisposition électrique		Prédisposition nacelle		Prédisposition pinces à pneus, pinces à vérins



Siège Social

B.P. 249 - 430 rue de l'Aubinière

44150 Ancenis Cedex - France

Tel: +33 (0)2 40 09 10 11 - Fax: +33 (0)2 40 09 10 97

www.manitou.com



Cette publication présente le descriptif des versions et possibilités de configuration des produits Manitou qui peuvent différer en équipement. Les équipements présentés dans cette brochure peuvent être de série, en option, ou non disponibles suivant les versions. Manitou se réserve le droit, à tout moment et sans préavis, de modifier les spécifications décrites et représentées. Les spécifications portées n'engagent pas le constructeur. Pour plus de détails, contactez votre concessionnaire Manitou. Document non contractuel. Présentation des produits non contractuelle. Liste des spécifications non exhaustive. Les logos ainsi que l'identité visuelle de l'entreprise sont la propriété de Manitou et ne peuvent être utilisés sans autorisation. Tous droits réservés. Les photos et schémas contenus dans la présente brochure ne sont fournis qu'à des fins de consultation et à titre indicatif.

Manitou BF SA - Société anonyme à conseil d'administration - Capital social : 39 668 399 euros - 857 802 508 RCS Nantes