

SQUARE WRAPPED BALE CLAMP (COMPACT MACHINES)

CLAMPS

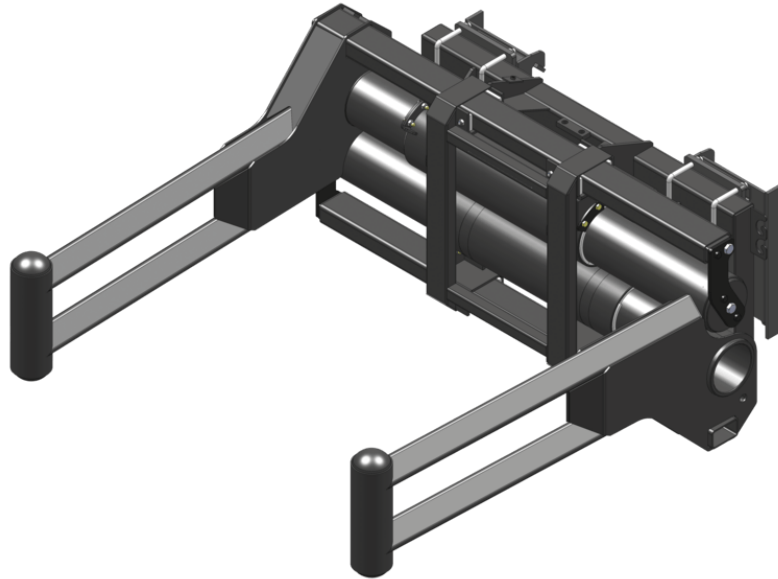

GEHL®

Customer benefits

- Tubular structure- no risk of damaging the film when moving wrapped bales.
- Wide clamp opening for big or multiple bale handling.
- Superior component protection.
- Multi-task: designed for wrapped square bales, can also handle standard square bales or round bales.







Technical characteristics

- Strong frame & components for intensive applications.
- Telescopic cinematics-smooth movement & strong clamping capacity.
- Massive use of Teflon® pad.
- Limited maintenance.
- Standard pressure limiter.

MANITOU GROUP ATTACHMENTS

| Capacities | | CLBSW 2000 / 1000 |
|-----------------------|-----|---|
| Capacity (kg) | | 1000 |
| Weight | | |
| Overall weight (kg) | | 477 |
| Weight and dimensions | | |
| Overall height (mm) | h17 | 679 |
| Arm length (mm) | | 1811 |
| Working Parameters | | |
| Machine Equipment | |  |
| Opening minimum (mm) | | 740 |
| Opening maximum (mm) | | 2090 |

| Compatibilità della macchina | | CLBSW 2000 / 1000 |
|------------------------------|--|-------------------|
| All-Tach® | | NS1502694 |
| 4 point Carriage | | NS1502693 |
| Euro Carriage | | NS1502692 |
| AL650 | | X |
| AL750 | | X |
| ALT750 | | X |
| MLA 6-65 H-Z | | X |
| MLA-T 516-75 H | | X |
| ALT750 OLD | | X |
| ALT750 OLD | | X |

| TABELLA DEI SIMBOLI | | | | | |
|---|-----------------------------------|---|-----------------------------|---|--|
|  | Nessuna predisposizione richiesta |  | Linea idraulica |  | Ritorno idraulico al serbatoio |
|  | Predisposizione elettrica |  | Predisposizione piattaforma |  | Predisposizione per la movimentazione dei pneumatici, dei cilindri |



GEHL®

Siège Social

P.O. Box 179 - One Gehl Way - West Bend, WI, USA 53095

Tel: (262) 334-9461 - Fax: (262) 338-7517

www.gehl.com



This brochure describes versions and configuration options for Gehl products which may be fitted with different equipment. The equipment described in this brochure may be standard, optional or not available depending on version. Gehl reserves the right to change the specifications shown and described at any time and without prior warning. The manufacturer is not liable for the specifications given. For more information, contact your Gehl dealer. Non-contractual document. Product descriptions may differ from actual products. List of specifications is not comprehensive. The logos and visual identity of the company are the property of Gehl and may not be used without authorization. All rights reserved. The photos and diagrams contained in this brochure are provided for information only.

MANITOU EQUIPMENT AMERICAS, LLC - Limited company with board of directors - Share capital: 39,668,399 euros - 857 802 508 RCS West Bend