

Технический паспорт ТЕХНИЧЕСКОЕ ОПИСАНИЕ :

# ЗАХВАТ ДЛЯ КВАДРАТНЫХ УПАКОВАННЫХ ТЮКОВ (ОБОРУДОВАНИЕ ДЛЯ КОМПАКТНЫХ МАШИН)

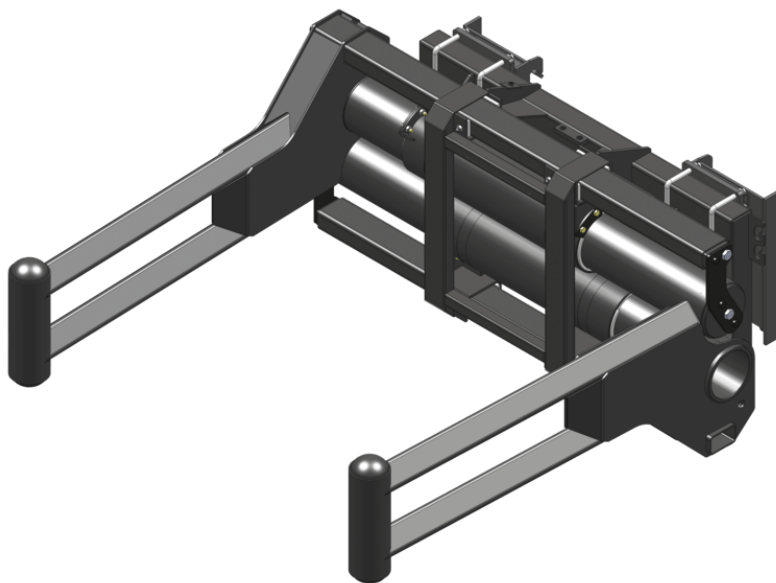

## Потребительские преимущества

- Трубчатая конструкция гарантирует отсутствие риска повреждения пленки при перемещении упакованных тюков.
- Широкий захват позволяет работать с большими или несколькими тюками.
- Превосходная защита компонентов.
- Многозадачность: разработан для квадратных упакованных тюков, также подходит для работы со стандартными квадратными и круглыми тюками.

## Технические характеристики

- Надежная рама и компоненты для интенсивного применения.
- Телескопическая кинематика: плавные движения и прочное удерживание тюка.
- Тефлоновые накладки.
- Сокращение объема техобслуживания.
- Стандартный ограничитель давления.

Грузоподъемность		CLBSW 2000 / 1000
Грузоподъемность (kg)		1000
Вес		
Общий вес (kg)		477
Вес и размеры		
Общая высота (mm)	h17	679
Длина плеча (mm)		1811
Рабочие характеристики		
Оборудование машины		
Минимальное раскрытие (mm)		740
Максимальное раскрытие (mm)		2090









Совместимость с машинами		CLBSW 2000 / 1000
Каретка All-Tach®		N51502694
4-х точечное крепление навесного оборудования		N51502693
Евро каретка		N51502692
AL650		X
AL750		X
ALT750		X
MLA 6-65 H-Z		X
MLA-T 516-75 H		X
ALT750 		X
ALT750 		X

ТАБЛИЦА СИМВОЛОВ					
	Не требуется предрасположенность		Гидравлическая линия		Гидравлическое возвращение в бак
	Электрическая предрасположенность		Предрасположение платформы		Предрасположение манипулятора шин, манипулятора цилиндров

**Головной офис**

В.Р. 249 - 430 rue de l'Aubinière

44150 Ancenis Cedex - France (Франция)

Телефон: 00 33 (0)2 40 09 10 11 - Факс: 00 33 (0)2 40 09 10 97

[www.manitou.com](http://www.manitou.com)

В данной брошюре описываются версии конфигурации и опции продуктов Manitou, которые могут отличаться в зависимости от оборудования. Описанное в данной брошюре оборудование может, в зависимости от версии, быть стандартным, опциональным или недоступным. Компания Manitou оставляет за собой право в любое время изменять приведенные и описанные характеристики без предварительного уведомления. Указанные технические характеристики не являются обязательными для производителя. Для получения дополнительной информации обратитесь к своему дилеру Manitou. Этот документ не имеет обязывающего, договорного характера. Описание продукции не имеет обязывающего, договорного характера. Список технических характеристик не является исчерпывающим. Логотипы и средства визуальной идентификации являются собственностью Manitou, их несанкционированное использование запрещено. Все права защищены. Фотографии и схемы в этой брошюре предоставлены только для ознакомления и в качестве справочной информации.

Manitou BF SA – Компания с ограниченной ответственностью и советом директоров – Акционерный капитал: 39 668 399 евро – Номер 857 802 508 в Реестре коммерсантов и предприятий Нанта