

Technical sheet :

# **TILTING FORKS CARRIAGE WITH SIDE SHIFT (MLT - MT)**

---

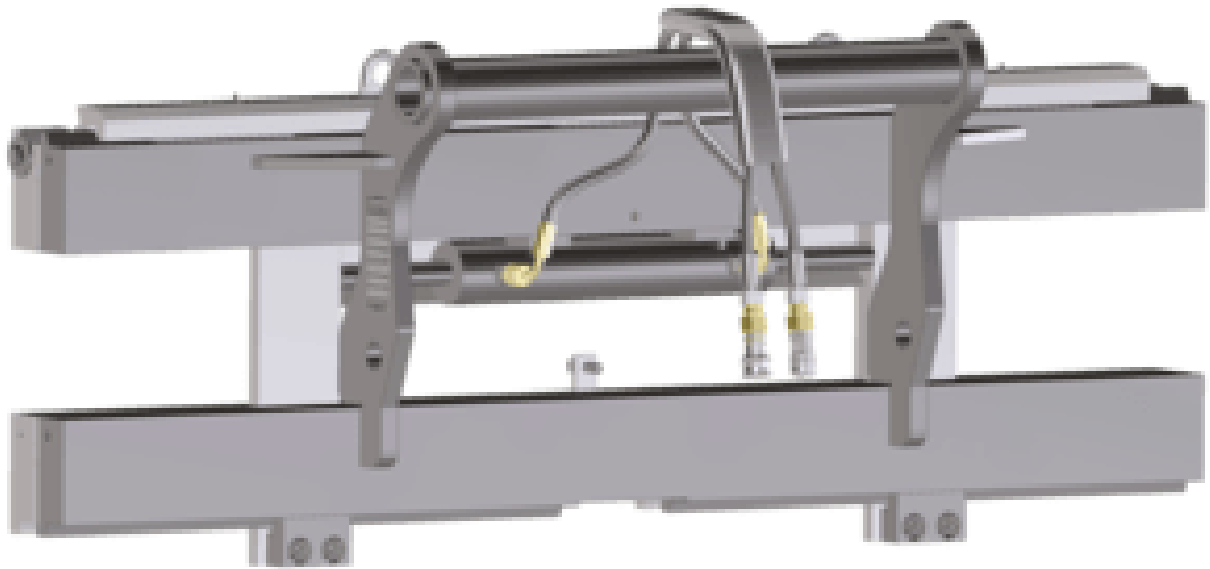





---







## **Technical characteristics**

- Hydraulic line required to allow fork movement from the cab.
- Tilting forks.
- Forks compliant with FEM/ISO standard, forks' length according to model.
- Forks are not included in the PFB, order 2 forks (except for CAT 1260/5T SS + F 150x50x1200 reference).

 **ATTACHMENTS**

Capacities		PFB 25N 1020 SS	PFB 25N 1260 SS	PFB 35N 1260 SS	PFB 35N 1580 SS	PFB 45N 1670 SS
Capacity (kg)		2500	2500	3500	3500	4500
Weight						
Overall weight (kg)		135	145	175	300	540
Weight and dimensions						
Overall height (mm)	h17	553	554	658	658	666
Width (mm)		1020	1260	1260	1580	1670
Working Parameters						
Machine Equipment						
Side shift (mm)		100	100	100	100	100
Available fork dimensions						
125 x 45 x 1200		52000099	52000100	52000101	52000102	
125 x 50 x 1200						52000103

Machines compatibility	PFB 25N 1020 SS	PFB 25N 1260 SS	PFB 35N 1260 SS	PFB 35N 1580 SS	PFB 45N 1670 SS
MLT 625-75 H	X	X	-	-	-
MLT 733-115	-	-	X	-	-
MLT 733-115 LSU	-	-	X	-	-
MLFX 625-75 H	X	X	-	-	-
MT 625 e	X	X	-	-	-
MT 625 H	X	X	-	-	-
MT 625 H COMFORT UK, R1	X	X	-	-	-
MT 625 H COMFORT, R1	X	X	-	-	-
MT 625 H, R1	X	X	-	-	-
MT 625 HA	X	X	-	-	-
MT 733 Easy	-	-	X	X	-
MT 735 75D ST5	-	-	X	X	-
MT 933 Easy	-	-	X	X	-
MT 935 75D ST5	-	-	X	X	-
MT 1033 easy	-	-	X	X	-
MT 1135 75 D	-	-	X	X	-
MT 1135 H 100D	-	-	X	X	-
MT 1135 easy ST5	-	-	X	X	-
MT 1135 H easy ST5	-	-	X	X	-
MT 1135 HA Easy ST5	-	-	X	X	-
MT 1135 ST5	-	-	X	X	-
MT 1335 75D ST5	-	-	X	X	-
MT 1335 100D ST5	-	-	X	X	-
MT 1335	-	-	X	X	-
MT 1335 easy ST5	-	-	X	X	-
MT 1335 H 75D ST5	-	-	X	X	-
MT 1335 H 100D ST5	-	-	X	X	-
MT 1335 H easy ST5	-	-	X	X	-
MT 1335 HA 75D ST5	-	-	X	X	-
MT 1335 HA 100D ST5	-	-	X	X	-
MT 1335 HA easy ST5	-	-	X	X	-
MT 1335 ST5	-	-	X	X	-
MT 1440 A	-	-	-	-	X
MT 1440 A ST5	-	-	-	-	X
MT 1440 easy ST5	-	-	-	-	X
MT 1440 HA	-	-	-	-	X
MT 1440 HA ST5	-	-	-	-	X
MT 1440 ST5	-	-	-	-	X
MT 1840 A 100D ST5 S1	-	-	-	-	X
MT 1840 A	-	-	-	-	X
MT 1840 easy ST5	-	-	-	-	X
MT 1840 HA	-	-	-	-	X
MT 1840 HA	-	-	-	-	X
MT 1840 ST5	-	-	-	-	X
MTX 625 H	X	X	-	-	-
MTX 733	-	-	X	X	-
MTX 1033	-	-	X	X	-
MTX 1440	-	-	-	-	X
MTX 1440 A	-	-	-	-	X
MTX 1840	-	-	-	-	X
MTX 1840 A	-	-	-	-	X
MLT 733-115 LSU ST4 <b>OLD</b>	-	-	X	-	-
MLT 733-115 ST4 <b>OLD</b>	-	-	X	-	-
MT 1135 <b>OLD</b>	-	-	X	X	-
MT 1440 <b>OLD</b>	-	-	-	-	X
MT 1840 <b>OLD</b>	-	-	-	-	X

TABLE SYMBOL					
	No predisposition required		Hydraulic line		Return piping to hydraulic oil tank
	Electric predisposition		Platform predisposition		Tyre handler, cylinder handler predisposition



**Head Office**

B.P. 249 - 430 rue de l'Aubinière

44150 Ancenis Cedex - France

Tel: +33 (0)2 40 09 10 11 - Fax: +33 (0)2 40 09 10 97

[www.manitou.com](http://www.manitou.com)



This publication provides a description of the configuration versions and options for Manitou products, which may differ for equipment. The equipment presented in this brochure may be part of a series, as an option, or it may not be available, depending on the versions. Manitou reserves the right, at any time and without notice, to amend the specifications described and represented. The specifications provided do not bind the manufacturer. For more details, please contact your Manitou agent. This is not a contractually binding document. The presentation of the products is not contractually binding. List of specifications non-exhaustive. The logos as well as the visual identity of the company are owned by Manitou and cannot be used without authorisation. All rights reserved. The photos and diagrams contained in this brochure are only provided for consultation and information purposes.

MANITOU BF SA - Limited company with board of directors - Share capital: 39,668,399 euros - 857 802 508 RCS Nantes