

Ficha técnica :

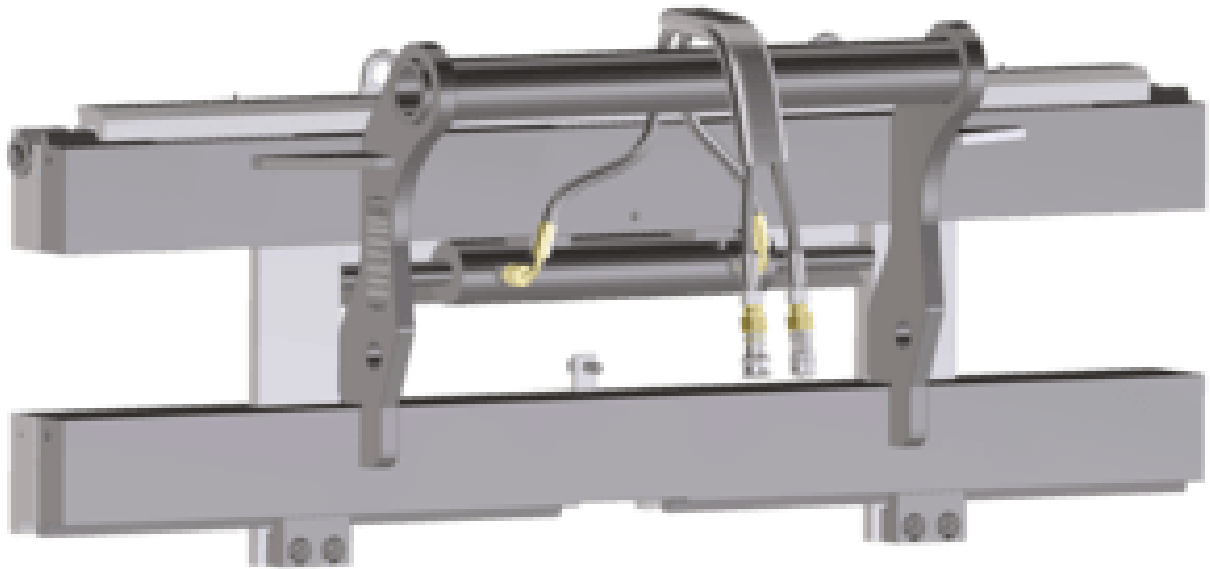



# **TILTING FORKS CARRIAGE WITH SIDE SHIFT (MLT - MT)**









## **Technical characteristics**

- Hydraulic line required to allow fork movement from the cab.
- Tilting forks.
- Forks compliant with FEM/ISO standard, forks' length according to model.
- Forks are not included in the PFB, order 2 forks (except for CAT 1260/5T SS + F 150x50x1200 reference).

**MANITOU**  
GROUP ATTACHMENTS

Capacities		PFB 25N 1020 SS	PFB 25N 1260 SS	PFB 35N 1260 SS	PFB 35N 1580 SS	PFB 45N 1670 SS
Capacity (kg)		2500	2500	3500	3500	4500
Weight						
Overall weight (kg)		135	145	175	300	540
Weight and dimensions						
Overall height (mm)	h17	553	554	658	658	666
Width (mm)		1020	1260	1260	1580	1670
Working Parameters						
Machine Equipment						
Side shift (mm)		100	100	100	100	100
<b>Dimensiones de horquilla disponibles</b>						
125 x 45 x 1200		52000099	52000100	52000101	52000102	
125 x 50 x 1200						52000103

Compatibilidad de la máquina	PFB 25N 1020 SS	PFB 25N 1260 SS	PFB 35N 1260 SS	PFB 35N 1580 SS	PFB 45N 1670 SS
MLT 625-75 H	X	X	-	-	-
MLT 733-115	-	-	X	-	-
MLT 733-115 LSU	-	-	X	-	-
MLFX 625-75 H	X	X	-	-	-
MT 625 e	X	X	-	-	-
MT 625 H	X	X	-	-	-
MT 625 H COMFORT UK, R1	X	X	-	-	-
MT 625 H COMFORT, R1	X	X	-	-	-
MT 625 H, R1	X	X	-	-	-
MT 625 HA	X	X	-	-	-
MT 733 Easy	-	-	X	X	-
MT 735 75D ST5	-	-	X	X	-
MT 933 Easy	-	-	X	X	-
MT 935 75D ST5	-	-	X	X	-
MT 1033 easy	-	-	X	X	-
MT 1135 75 D	-	-	X	X	-
MT 1135 H 100D	-	-	X	X	-
MT 1135 easy ST5	-	-	X	X	-
MT 1135 H easy ST5	-	-	X	X	-
MT 1135 HA Easy ST5	-	-	X	X	-
MT 1135 ST5	-	-	X	X	-
MT 1335 75D ST5	-	-	X	X	-
MT 1335 100D ST5	-	-	X	X	-
MT 1335	-	-	X	X	-
MT 1335 easy ST5	-	-	X	X	-
MT 1335 H 75D ST5	-	-	X	X	-
MT 1335 H 100D ST5	-	-	X	X	-
MT 1335 H easy ST5	-	-	X	X	-
MT 1335 HA 75D ST5	-	-	X	X	-
MT 1335 HA 100D ST5	-	-	X	X	-
MT 1335 HA easy ST5	-	-	X	X	-
MT 1335 ST5	-	-	X	X	-
MT 1440 A	-	-	-	-	X
MT 1440 A ST5	-	-	-	-	X
MT 1440 easy ST5	-	-	-	-	X
MT 1440 HA	-	-	-	-	X
MT 1440 HA ST5	-	-	-	-	X
MT 1440 ST5	-	-	-	-	X
MT 1840 A 100D ST5 S1	-	-	-	-	X
MT 1840 A	-	-	-	-	X
MT 1840 easy ST5	-	-	-	-	X
MT 1840 HA	-	-	-	-	X
MT 1840 HA	-	-	-	-	X
MT 1840 ST5	-	-	-	-	X
MTX 625 H	X	X	-	-	-
MTX 733	-	-	X	X	-
MTX 1033	-	-	X	X	-
MTX 1440	-	-	-	-	X
MTX 1440 A	-	-	-	-	X
MTX 1840	-	-	-	-	X
MTX 1840 A	-	-	-	-	X
MLT 733-115 LSU ST4 <b>OLD</b>	-	-	X	-	-
MLT 733-115 ST4 <b>OLD</b>	-	-	X	-	-
MT 1135 <b>OLD</b>	-	-	X	X	-
MT 1440 <b>OLD</b>	-	-	-	-	X
MT 1840 <b>OLD</b>	-	-	-	-	X

TABLA DE SÍMBOLOS					
	No se requiere predisposición		Línea hidráulica		Retorno al depósito de aceite hidráulico
	Predisposición eléctrica		Predisposición de la plataforma		Predisposición manipulador de neumáticos, de cilindros



**Oficina Central**

B.P. 249 - 430 rue de l'Aubinière

44150 Ancenis Cedex - Francia

Tel.: 00 33 (0)2 40 09 10 11 - Fax: 00 33 (0)2 40 09 10 97

[www.manitou.com](http://www.manitou.com)



Esta publicación describe las versiones y posibilidades de configuración de los productos Manitou que puedan diferir en equipamiento. Los equipamientos presentados en este folleto pueden ser de serie, opcionales o no estar disponibles en algunas versiones. Manitou se reserva el derecho, en cualquier momento y sin previo aviso, de modificar las especificaciones descritas y representadas. Las especificaciones aportadas no comprometen al fabricante. Para más información, póngase en contacto con su concesionario Manitou. Documento no contractual. Presentación de los productos no contractual. Lista de especificaciones no exhaustiva. Los logos y la identidad visual de la empresa son propiedad de Manitou y no pueden ser utilizados sin autorización. Todos los derechos reservados. Las fotos y los esquemas contenidos en este folleto se ofrecen para consulta y a título indicativo solamente.

Manitou BF SA - Sociedad anónima con Consejo de Administración - Capital social: 39 668 399 euros - 857 802 508 RCS Nantes