

Ficha técnica :

VARIOWINCH



Customer benefits

- Turns your telehandler into a crane.
- 4x faster than a standard Manitou 5t winch / 3x faster than a 3t one.
- Speed is continuously adapted to the load & operator's speed requirement.
- Max. speed 60m/min (MRT 3255, no load, lifting).
- Easy steering from the cab or with the machine's remote control (optional).







Technical characteristics

- Hydraulic motor + end of cable automatic movement stop.
- Oil immersed negative break.
- Patented variable speed concept.
- Autonomous, 100% hydraulic speed adaptation to load.
- Homologated swivel self locking hook.
- Winch storage stand with sleeves for yard handling.
- Note: dimensions below are given for winch placed on its stands ; working weight: 700kg.
- MRT Vision+ : significant hook speed increase through machine/attachment cooperation improvement.
- Limited capacity for MRT 3050.

[The 3D picture at the top of this page is the reference VARIOWINCH 7.2 t - 52576737].

Technical characteristics		W 7200 V
Working height (mm)	h21	36000
Capacities		
Capacity (kg)		7200
Weight		
Overall weight (kg)		700
Dimensions		
Max. outreach (mm)		238
Weight and dimensions		
Overall height (mm)	h17	2408
Overall length (mm)	l1	1200
Cable loop		1
Width (mm)		1223
Depth (mm)	p5	638
Cable length (mm)		76000
Working Parameters		
Machine Equipment		
Hook Speed (m/mn)		60.60

Compatibilidad de la máquina		W 7200 V
Reference number E-RECO		52735674
MRT 2260		X
MRT 2260 e		X
MRT 2570		X
MRT 2660		X
MRT 2660 e		X
MRT 3060		X
MRT 3570		X
MRT 3570 ES		X
MRT-X 2260		X
MRT-X 2570		X
MRT-X 2660		X
MRT-X 3060		X
MRT-X 3570		X
MRT-X 3570 ES		X

TABLA DE SÍMBOLOS					
	No se requiere predisposición		Línea hidráulica		Retorno al depósito de aceite hidráulico
	Predisposición eléctrica		Predisposición de la plataforma		Predisposición manipulador de neumáticos, de cilindros

Variowinch - Diagrama dimensional

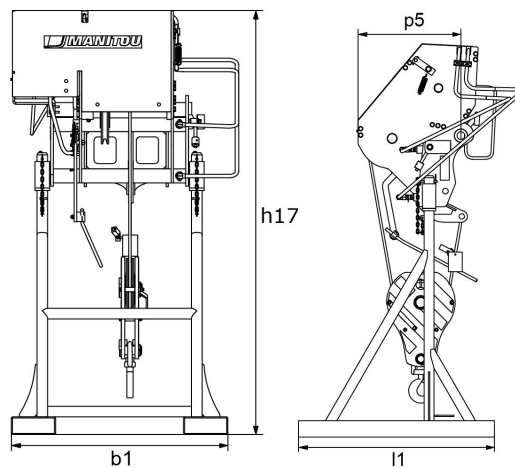



 **MANITOU**
HANDLING YOUR WORLD

Oficina Central

B.P. 249 - 430 rue de l'Aubinière

44150 Ancenis Cedex - Francia

Tel.: 00 33 (0)2 40 09 10 11 - Fax: 00 33 (0)2 40 09 10 97

www.manitou.com



Esta publicación describe las versiones y posibilidades de configuración de los productos Manitou que puedan diferir en equipamiento. Los equipamientos presentados en este folleto pueden ser de serie, opcionales o no estar disponibles en algunas versiones. Manitou se reserva el derecho, en cualquier momento y sin previo aviso, de modificar las especificaciones descritas y representadas. Las especificaciones aportadas no comprometen al fabricante. Para más información, póngase en contacto con su concesionario Manitou. Documento no contractual. Presentación de los productos no contractual. Lista de especificaciones no exhaustiva. Los logos y la identidad visual de la empresa son propiedad de Manitou y no pueden ser utilizados sin autorización. Todos los derechos reservados. Las fotos y los esquemas contenidos en este folleto se ofrecen para consulta y a título indicativo solamente.

Manitou BF SA - Sociedad anónima con Consejo de Administración - Capital social: 39 668 399 euros - 857 802 508 RCS Nantes