

Ficha técnica :

VARIOWINCH





Características técnicas

- Hydraulic motor + end of cable automatic movement stop.
- Oil immersed negative break.
- Patented variable speed concept.
- Autonomous, 100% hydraulic speed adaptation to load.
- Homologated swivel self locking hook.
- Winch storage stand with sleeves for yard handling.
- Note: dimensions below are given for winch placed on its stands ; working weight: 700 kg / 1544 lb.
- MRT Vision+ : significant hook speed increase through machine/attachment cooperation improvement.
- Limited capacity for MRT 3050.







[The 3D picture at the top of this page is the reference VARIOWINCH 7.2 t - 52576737].

Beneficios para el cliente

- Turns your telehandler into a crane.
- 4x faster than a standard Manitou 5 t / 11025 lb winch / 3x faster than a 3 t / 6615 lb one.
- Speed is continuously adapted to the load & operator's speed requirement.
- Max. speed 60 m/min / 197 ft/min (MRT 3255, no load, lifting).
- Easy steering from the cab or with the machine's remote control (optional).

Características técnicas		W 7200 V	W 8000 / 54 V
Distancia al centro de gravedad (mm)		-	409
Altura de trabajo (mm)	h21	36000	54000
Capacidad			
Capacidad (kg)		7200	8000
Weight			
Peso (kg)		700	950
Dimensions			
Alcance máx (mm)		238	522
Peso y dimensión			
Altura total (mm)	h17	2408	2028
Longitud total (mm)	l1	1200	1000
Presilla del cable		1 circuito	1 circuito
Anchura (mm)		1223	1316
Fondo (mm)	p5	638	-
Largo de cable (mm)		76000	-
Parámetros de trabajo			
Equipamiento de máquina			
Velocidad de gancho (m/mn)		60.60	40
Otros datos para accesorios			
E-RECO		-	Yes

Compatibilidad de la máquina	W 7200 V	W 8000 / 54 V
Número de referencia E-RECO	52735674	52809400
MRT 2260	X	-
MRT 2260 e	X	-
MRT 2570	X	-
MRT 2660	X	-
MRT 2660 e	X	-
MRT 3060	X	-
MRT 3570	X	-
MRT 3570 ES	X	-
MRT 4080	-	X
MRT-X 2260	X	-
MRT-X 2570	X	-
MRT-X 2660	X	-
MRT-X 3060	X	-
MRT-X 3570	X	-
MRT-X 3570 ES	X	-
MRT-X 4080	-	X

TABLA DE SÍMBOLOS					
	No se requiere predisposición		Línea hidráulica		Retorno al depósito de aceite hidráulico
	Predisposición eléctrica		Predisposición de la plataforma		Predisposición manipulador de neumáticos, de cilindros

Variowinch - Diagrama dimensional

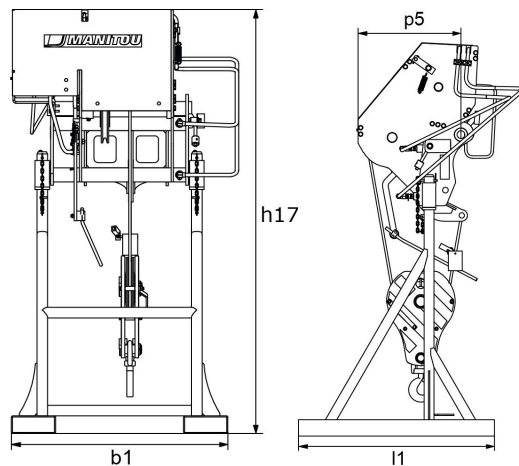



 **MANITOU**
HANDLING YOUR WORLD

Oficina Central

B.P. 249 - 430 rue de l'Aubinière

44150 Ancenis Cedex - Francia

Tel.: 00 33 (0)2 40 09 10 11 - Fax: 00 33 (0)2 40 09 10 97

www.manitou.com



Esta publicación describe las versiones y posibilidades de configuración de los productos Manitou que puedan diferir en equipamiento. Los equipamientos presentados en este folleto pueden ser de serie, opcionales o no estar disponibles en algunas versiones. Manitou se reserva el derecho, en cualquier momento y sin previo aviso, de modificar las especificaciones descritas y representadas. Las especificaciones aportadas no comprometen al fabricante. Para más información, póngase en contacto con su concesionario Manitou. Documento no contractual. Presentación de los productos no contractual. Lista de especificaciones no exhaustiva. Los logos y la identidad visual de la empresa son propiedad de Manitou y no pueden ser utilizados sin autorización. Todos los derechos reservados. Las fotos y los esquemas contenidos en este folleto se ofrecen para consulta y a título indicativo solamente.

Manitou BF SA - Sociedad anónima con Consejo de Administración - Capital social: 39 668 399 euros - 857 802 508 RCS Nantes