

Fiche technique :

# ME 450 FOB



 **MANITOU**  
HANDLING YOUR WORLD

Caractéristiques techniques		Métrique	
1.1	Fabricant		Manitou
1.2	Modèle		ME 450 FOB
1.3	Source d'alimentation		Électrique - Plomb
1.4	Type de conduite		Assis
1.5	Capacité max.	Q	5000 kg
1.6	Centre de gravité de la charge	c	500 mm
1.8	Distance du centre de l'essieu avant aux fourches	x	500 mm
1.9	Empattement	y	2000 mm
Poids			
2.1	Poids de service		7100 kg
2.2	Poids sur essieu avant (en charge) / arrière (en charge)		10635 kg / 1465 kg
2.3	Poids sur essieu avant (à vide) / arrière (à vide)		3625 kg / 3475 kg
Roues			
3.1	Type de roues		Pneus pleins
3.2	Dimensions roues avant		250/15
3.3	Dimensions roues arrière		7.00-12
3.5	Nombre de roues avant / arrières		2 / 2
3.5.2	Nombre de roues motrices		2
3.6	Voie avant	b10	1130 mm
3.7	Voie (milieu des roues) arrière	b11	1100 mm
Dimensions			
4.8	Hauteur du siège / hauteur debout	h7	1235 mm
4.7	Hauteur du protège conducteur (cabine)	h6	2300 mm
4.12	Hauteur d'attelage	h10	460 mm
4.19	Longueur hors-tout	l1	4165 mm
4.20	Longueur au talon des fourches	l2	3015 mm
4.21	Largeur hors tout	b1	1380 mm
4.22	Section de fourches / Largeur de fourches / Longueur de fourches	s / e / l	150 mm x 1150 mm x 50 mm
4.23	Tablier porte-fourche suivant norme DIN 15173 A/B		3A
4.24	Largeur du tablier porte fourches (avec dossier de charge)	b3	1100 mm
4.31	Garde au sol sous le mât	m1	110 mm
4.32	Garde au sol au centre de l'empattement	m2	219 mm
4.33	Largeur d'allée pour palettes 1000 x 1200 transversales	Ast	4475 mm
4.34	Largeur d'allée pour palette 800 x 1200 en longueur	Ast	4675 mm
4.35	Rayon de giration	Wa	2720 mm
4.36	Rayon de braquage intérieur (extérieur pneus)	b13	805 mm
Performances			
5.1	Vitesse de déplacement (en charge / à vide)		13 km/h-13.50 km/h
5.2	Vitesse de levée (en charge / à vide)		0.26 m/s-0.40 m/s
5.3	Vitesse de descente (en charge / à vide)		0.50 m/s-0.30 m/s
5.5	Effort de traction en charge		2700 daN
5.7	Pente franchissable (en charge / à vide)		15 % / 16 %
5.10	Frein de service		Hydraulique
Moteur			
6.1	Puissance moteur translation (S2 60 min)		16.60 kW
6.2	Puissance du moteur de levage à S3 15 %		25.40 kW
6.3	Batterie conformément à la norme DIN 43531/35/36 A, B, C		DIN43536 A
6.4	Tension batterie / Capacité de la batterie		80 V / 700 Ah
6.6	Consommation d'énergie selon le cycle VDI (kWh/h)		15.30 kWh/h
Divers			
8.1	Type d'unité motrice		Électronique
8.2	Pression hydraulique de travail pour les accessoires		210 bar
8.3	Débit d'huile pour accessoire		65 l/min
8.4	Niveau sonore moyen à l'oreille du cariste mesuré/garanti		< 78 dB

## ME 450 FOB - Schémas d'encombrement

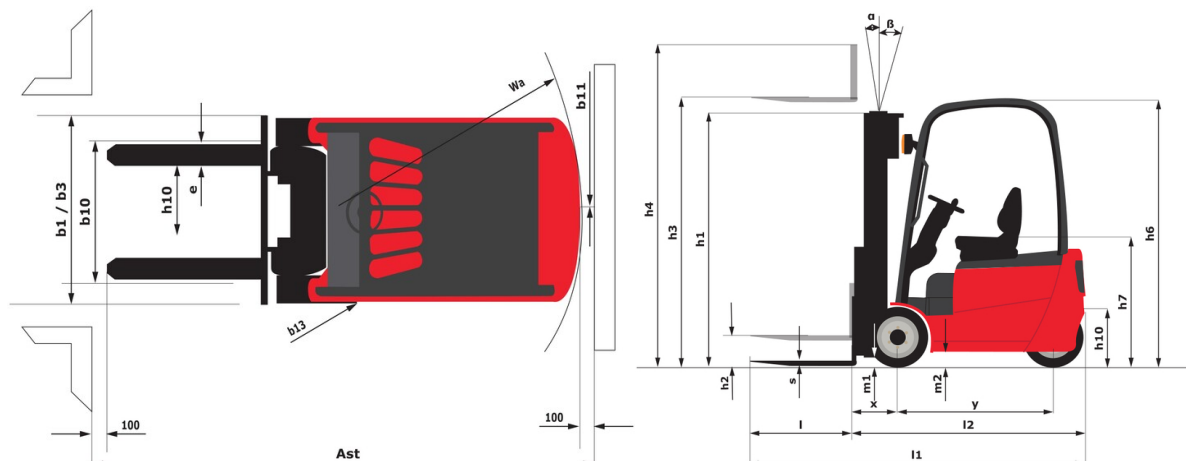

## Caractéristiques des mâts et capacités résiduelles

Duplex à visibilité totale (FVD)	FVD 30	FVD 33	FVD 35	FVD 40	FVD 43	FVD 45	FVD 48	FVD 50
α - Inclinaison du mât/tablier, avant °	6	6	6	6	6	6	6	6
β - Inclinaison du mât/tablier, arrière °	12	12	12	12	6	6	6	6
h1 - Hauteur du mât abaissé mm	2185	2335	2435	2735	2900	3010	3175	3285
h2 - Mât levée libre mm	150	150	150	150	150	150	150	150
h3 - Hauteur de levage mm	3000	3300	3500	4000	4300	4500	4800	5000
h4 - Hauteur mât déployé mm	3770	4070	4270	4770	5070	5270	5570	5770
Capacité résiduelle à hauteur maximale kg	5000	5000	5000	5000	4950	4900	4800	4700
Capacité résiduelle avec TDL intégré à hauteur max. kg	5000	5000	5000	5000	4900	4850	4750	4650
Capacité résiduelle avec TDL rapporté à hauteur maximum kg	4800	4800	4800	4800	4700	4600	4500	4400
Hauteur à la capacité maximale mm	3000	3300	3500	4000	4000	4000	4000	4000
Hauteur à capacité maximale avec tablier à déplacement latéral intégré mm	3000	3300	3500	4000	4000	4000	4000	4000

Duplex à levée libre (FLD)	FLD 30	FLD 33	FLD 40
α - Inclinaison du mât/tablier, avant °	6	6	6
β - Inclinaison du mât/tablier, arrière °	12	12	12
h1 - Hauteur du mât abaissé mm	2166	2316	2666
h2 - Mât levée libre mm	1365	1515	1865
h3 - Hauteur de levage mm	3000	3300	4000
h4 - Hauteur mât déployé mm	3805	4105	4805
Capacité résiduelle à hauteur maximale kg	5000	5000	5000
Capacité résiduelle avec TDL intégré à hauteur max. kg	5000	5000	5000
Capacité résiduelle avec TDL rapporté à hauteur maximum kg	4800	4800	4800
Hauteur à la capacité maximale mm	3000	3300	4000
Hauteur à capacité maximale avec tablier à déplacement latéral intégré mm	3000	3300	4000

Free Lift Triplex (FLT)	FLT 43	FLT 48	FLT 50	FLT 55	FLT 60
α - Inclinaison du mât/tablier, avant °	6	6	6	3	3
β - Inclinaison du mât/tablier, arrière °	6	6	6	6	6
h1 - Hauteur du mât abaissé mm	2120	2280	2350	2515	2730
h2 - Mât levée libre mm	1318	1478	1548	1710	1928
h3 - Hauteur de levage mm	4300	4800	5000	5500	6000
h4 - Hauteur mât déployé mm	5105	5605	5805	6305	6805
Capacité résiduelle à hauteur maximale kg	4800	4650	4450	4250	4100
Capacité résiduelle avec TDL intégré à hauteur max. kg	4700	4600	4400	4200	4050
Capacité résiduelle avec TDL rapporté à hauteur maximum kg	4500	4350	4150	3950	3800
Hauteur à la capacité maximale mm	2500	2500	2500	2500	2500



**Siège Social**

B.P. 249 - 430 rue de l'Aubinière  
44150 Ancenis Cedex - France

Tel: +33 (0)2 40 09 10 11 - Fax: +33 (0)2 40 09 10 97

[www.manitou.com](http://www.manitou.com)



Cette publication présente le descriptif des versions et possibilités de configuration des produits Manitou qui peuvent différer en équipement. Les équipements présentés dans cette brochure peuvent être de série, en option, ou non disponibles suivant les versions. Manitou se réserve le droit, à tout moment et sans préavis, de modifier les spécifications décrites et représentées. Les spécifications portées n'engagent pas le constructeur. Pour plus de détails, contactez votre concessionnaire Manitou. Document non contractuel. Présentation des produits non contractuelle. Liste des spécifications non exhaustive. Les logos ainsi que l'identité visuelle de l'entreprise sont la propriété de Manitou et ne peuvent être utilisés sans autorisation. Tous droits réservés. Les photos et schémas contenus dans la présente brochure ne sont fournis qu'à des fins de consultation et à titre indicatif.

Manitou BF SA - Société anonyme à conseil d'administration - Capital social : 39 668 399 euros - 857 802 508 RCS Nantes