

Scheda tecnica :

MT 1335 75D ST5



 **MANITOU**
HANDLING YOUR WORLD

Capacità		Metrico
Portata massima	Q	3500 kg
Altezza massima di sollevamento		12.60 m
Sbraccio massimo		8.65 m
Forza di strappo con benna		7400 daN
Peso e dimensioni		
Lunghezza al portaforche	l11	5.72 m
Lunghezza al piano forche	l2	5.72 m
Lunghezza (con forche)	l1	6.92 m
Larghezza	b1	2.28 m
Altezza	h17	2.48 m
Interasse	y	2.80 m
Altezza libera dal suolo	m4	0.42 m
Larghezza cabina	b4	0.95 m
Angolo di inclinazione verso l'alto	a4	13 °
Angolo di inclinazione in avanti	a5	114 °
Raggio di sterzata esterna	Wa3	3.78 m
Raggio di sterzata (esterno ruote)	Wa1	3.78 m
Peso a vuoto (con forche)		9470 kg
Peso		9470 kg
Tipo di ruote		Gomme pneumatiche
Modelli di pneumatici		Alliance 400/80 - 24 - 162A8
Lunghezza forche / Larghezza forche / Sezione forche	l / e / s	1200 mm x 100 mm x 50 mm
Performance		
Sollevamento		10.30 s
Abbassamento		9.60 s
Uscita sfilo		14.70 s
Rientro sfilo		9.90 s
Inclinazione verso l'alto		3.20 s
Inclinazione verso il basso		3.80 s
Motore		
Marca motore		Deutz
Norma motore		Stage V
Modello motore		TCD 2.9L
Numero di cilindri / Cilindrata		4 - 2924 cm ³
Potenza motore (CV/kW)		75 cv / 55.40 kW
Coppia massima / Regime motore		375 Nm @ 1400 rpm
Forza di trazione		9700 daN
Convalidato HVO (secondo la norma EN 15940)		SI
Circuito Elettrico		
12V Capacità batteria		110 Ah
Trasmissione		
Tipo di trasmissione		Convertitore di coppia
Numero di marce (avanti / indietro)		2 / 2
Velocità massima di spostamento		24.90 km/h
Freno stazionamento		Freno di stazionamento meccanico a pedale
Freno di servizio		Servofreno idraulico
Idraulico		
Tipo di pompa		Pistone assiale
Portata idraulica / Pressione idraulica		133 l/min-260 bar
Capacità del serbatoio		
Olio motore		8.50 l
Olio idraulico		153 l
Capacità del serbatoio del carburante.		137 l
Rumore e vibrazione		
Rumorosità al posto di guida (LpA)		77 dB
Rumorosità nell'ambiente (LwA)		104 dB
Vibrazione sul gruppo complesso mani/braccia		< 2.50 m/s ²
Varie		
Ruote direttrici (anteriori / posteriori)		2 / 2
Ruote motrici (anteriori / posteriori)		2 / 2
Sicurezza / Certificazione della cabina		Standard EN 15000 / Cabina ROPS - FOPS Livello 2
Comandi		JSM

MT 1335 75D ST5 - Disegno quotato



MT 1335 75D ST5 - Diagramma di carico

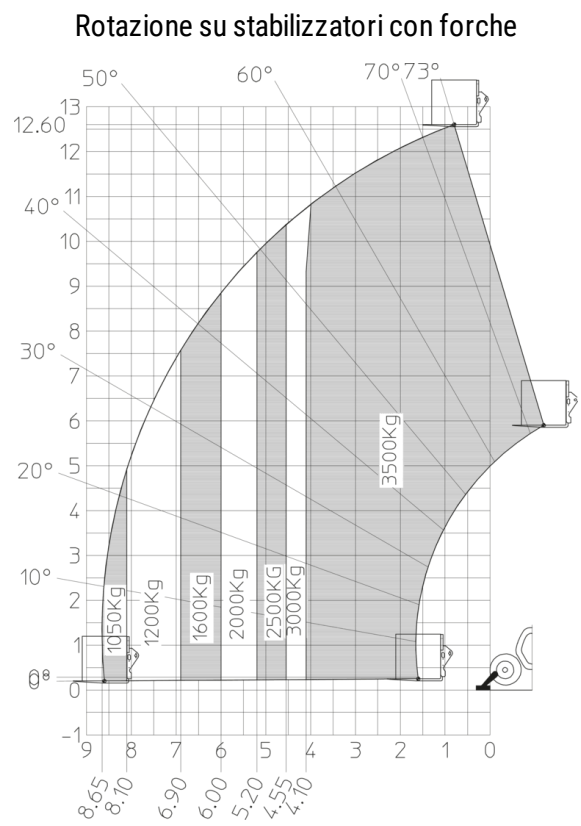



 **MANITOU**
HANDLING YOUR WORLD

Sede centrale
MANITOU ITALIA Srl
Via Cristoforo Colombo 2, Loc. Cavazzona - 41013 CASTELFRANCO EMILIA (MO)
Tel: 059.95.98.11 - Fax 059.95.98.65
www.manitou.com



Questa pubblicazione presenta la descrizione delle versioni e delle possibilità di configurazione dei prodotti Manitou, che possono differire per attrezzature. Gli allestimenti presentati nel presente opuscolo possono essere di serie, optional o non disponibili, a seconda delle versioni. Manitou si riserva il diritto di modificare, in qualsiasi momento e senza alcun preavviso, le specifiche tecniche descritte e rappresentate. Le specifiche indicate non rappresentano alcun obbligo per il costruttore. Per maggiori dettagli, rivolgersi al proprio concessionario Manitou. Documento non contrattuale. Elenco delle specifiche non esaustivo. I loghi nonché l'identità visiva dell'azienda sono di proprietà di Manitou e non possono essere utilizzati senza autorizzazione. Tutti i diritti riservati. Le immagini e gli schemi contenuti nel presente opuscolo sono forniti esclusivamente a fini di consultazione e a titolo indicativo.

Manitou BF SA - Società anonima con consiglio di amministrazione. Capitale sociale: 39,668,399 euro - 857 802 508 RCS Nantes