

Technical sheet :

EP 730



 **MANITOU**
HANDLING YOUR WORLD

Technical characteristics			Metric
1.1	Manufacturer		Manitou
1.2	Model Name		EP 730 S1
1.3	Power source		Electrical
1.4	Operator type		Pedestrian
1.5	Max. capacity	Q	3000 kg
1.6	Load center of gravity	c	600 mm
1.8	Load distance, centre of drive axle to fork	x	865 mm
1.9	Wheelbase	y	1269 mm
Weight			
2.1	Service weight		1340 kg
Wheels			
3.1	Tires type		Bandage
3.2	Dimensions of front wheels		254 x 100
3.3	Dimensions of rear wheels		82 x 100
3.4	Size of the stabilizer wheels		125 x 50
3.5.2	Number of drive wheels / front wheels / rear wheels		1 / 3 / 4
3.6	Front wheel gauge	b10	775 mm
3.7	Rear wheel gauge	b11	370 mm
Dimensions			
4.15	Fork height in low position	h13	85 mm
4.19	Overall length	l1	1880 mm
4.20	Length to face of forks	l2	725 mm
4.21	Overall width	b1	980 mm
4.22	Forks section / width / length	s / e / l	60 mm x 200 mm x 1150 mm
4.25	Fork spread	b5	570 mm
4.32	Ground clearance at centre of wheelbase	m2	25 mm
4.34	Aisle width for 800 x 1200 pallet lengthways	Ast	2150 mm
4.35	Turning radius	Wa	1615 mm
4.4	Mast lifting height	h3	112 mm
4.9	Height tiller min.	h14	1030 mm
4.9	Height tiller max.	h14	1490 mm
Performances			
5.1	Travel speed (laden / unladen)		5 km/h / 5 km/h
5.7	Gradeability (laden / unladen)		5 % / 10 %
5.10	Service brake		Electro magnetic
5.11	Parking brake		Handle Release
Engine			
6.1	Drive motor rating S2 60 min		2 kW
6.2	Lift motor rating at S3 15%		2 kW
6.3	Battery according to DIN 43531/35/36 A, B, C		DIN 43535-B
6.4	Battery voltage / capacity		24 V / 315 Ah
6.5	Battery weight (+/- 5%)		280 kg
Miscellaneous			
8.1	Type of drive control		DC
8.4	Measured/guaranteed mean noise level at the ear of the operator		< 75 dB

EP 730 - Dimensional drawing

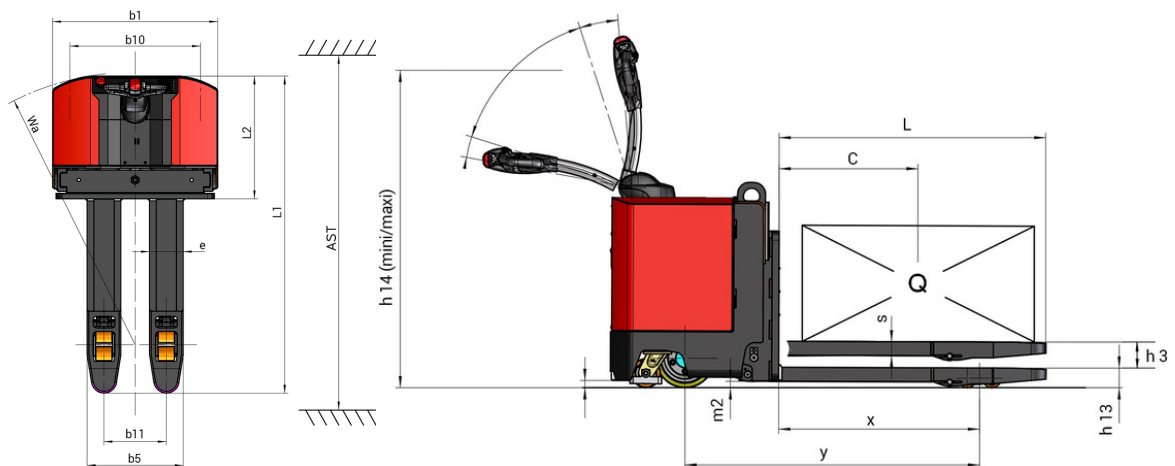

**Head Office**

B.P. 249 - 430 rue de l'Aubinière

44150 Ancenis Cedex - France

Tel: +33 (0)2 40 09 10 11 - Fax: +33 (0)2 40 09 10 97

www.manitou.com

This publication provides a description of the configuration versions and options for Manitou products, which may differ for equipment. The equipment presented in this brochure may be part of a series, as an option, or it may not be available, depending on the versions. Manitou reserves the right, at any time and without notice, to amend the specifications described and represented. The specifications provided do not bind the manufacturer. For more details, please contact your Manitou agent. This is not a contractually binding document. The presentation of the products is not contractually binding. List of specifications non-exhaustive. The logos as well as the visual identity of the company are owned by Manitou and cannot be used without authorisation. All rights reserved. The photos and diagrams contained in this brochure are only provided for consultation and information purposes.

MANITOU BF SA - Limited company with board of directors - Share capital: 39,668,399 euros - 857 802 508 RCS Nantes