

Technical sheet :

# **EP 20 INOX PREMIUM**



 **MANITOU**  
HANDLING YOUR WORLD

Technical characteristics			Metric
1.1	Manufacturer		Manitou
1.2	Model Name		EP 20 Inox Premium
1.3	Power source		Electrical - Lead
1.4	Operator type		Pedestrian
1.5	Max. capacity	Q	2000 kg
1.6	Load center of gravity	c	600 mm
1.8	Load distance, centre of drive axle to fork	x	954 mm
1.9	Wheelbase	y	1379 mm
Weight			
2.1	Service weight		482 kg
2.2	Weight on front axle (laden) / rear axle (laden)		1077 kg / 1405 kg
2.3	Weight on front axle (Unladen) / rear axle (Unladen)		337 kg / 145 kg
Wheels			
3.1	Tires type		Polyurethane cushion
3.2	Dimensions of front wheels		230 x 70
3.3	Dimensions of rear wheels		82 x 68
3.5.2	Number of drive wheels / front wheels / rear wheels		1 / 2 / 4
3.6	Front wheel gauge	b10	435 mm
3.7	Rear wheel gauge	b11	365 mm
Dimensions			
4.15	Fork height in low position	h13	85 mm
4.19	Overall length	l1	1750 mm
4.20	Length to face of forks	l2	599 mm
4.21	Overall width	b1	680 mm
4.22	Forks section / width / length	s / e / l	45 mm x 175 mm x 1150 mm
4.25	Forks spread	b5	540 mm
4.32	Ground clearance at centre of wheelbase	m2	40 mm
4.34	Aisle width for 800 x 1200 pallet lengthways	Ast	2170 mm
4.35	Turning radius	Wa	1560 mm
4.4	Mast lifting height	h3	125 mm
4.9	Height tiller min.	h14	880 mm
4.9	Height tiller max.	h14	1330 mm
Performances			
5.1	Travel speed (laden / unladen)		5 km/h / 5 km/h
5.2	Lifting speed (laden / unladen)		0.02 m/s / 0.03 m/s
5.3	Lowering speed (laden / unladen)		0.04 m/s / 0.02 m/s
5.7	Gradeability (laden / unladen)		10 % / 25 %
5.10	Service brake		Electro magnetic
5.11	Parking brake		Handle Release
Engine			
6.1	Drive motor rating S2 60 min		1.20 kW
6.2	Lift motor rating at S3 15%		1 kW
6.3	Battery according to DIN 43531/35/36 A, B, C		DIN 43535-B
6.4	Battery voltage / capacity		24 V / 180 Ah
6.5	Battery weight (+/- 5%)		180 kg
Miscellaneous			
8.1	Type of drive control		AC
8.4	Measured/guaranteed mean noise level at the ear of the operator		< 75 dB

### EP 20 Inox Premium - Dimensional drawing

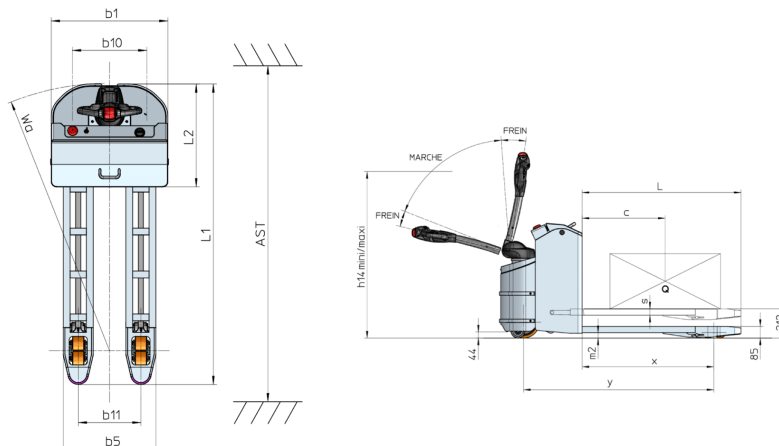



**Head Office**

B.P. 249 - 430 rue de l'Aubinière  
44150 Ancenis Cedex - France

Tel: +33 (0)2 40 09 10 11 - Fax: +33 (0)2 40 09 10 97

[www.manitou.com](http://www.manitou.com)



This publication provides a description of the configuration versions and options for Manitou products, which may differ for equipment. The equipment presented in this brochure may be part of a series, as an option, or it may not be available, depending on the versions. Manitou reserves the right, at any time and without notice, to amend the specifications described and represented. The specifications provided do not bind the manufacturer. For more details, please contact your Manitou agent. This is not a contractually binding document. The presentation of the products is not contractually binding. List of specifications non-exhaustive. The logos as well as the visual identity of the company are owned by Manitou and cannot be used without authorisation. All rights reserved. The photos and diagrams contained in this brochure are only provided for consultation and information purposes.

MANITOU BF SA - Limited company with board of directors - Share capital: 39,668,399 euros - 857 802 508 RCS Nantes