

Technical sheet :

# **TMT-X 25 S K**

---



 **MANITOU**  
HANDLING YOUR WORLD

Technical characteristics		Metric	
1.1	Manufacturer		Manitou
1.2	Model Name		TMT-X 25 S K
1.2.1	Reach out equipment		Telescopic boom
1.3	Power source		Diesel
1.4	Operator type		Seated
1.5	Max. capacity	Q	2500 kg
1.6	Load center of gravity	c	500 mm
1.8	Load distance, centre of drive axle to fork	x	-505 mm
1.9	Wheelbase	y	1651 mm
<b>Weight</b>			
2.1	Service weight		2615 kg
<b>Wheels</b>			
3.1	Tires type		Pneumatic
3.2	Dimensions of front wheels		10 x 16.5
3.3	Dimensions of rear wheels		10 x 16,5
3.5	Number of front wheels / rear wheels		2 / 1
3.5.2	Drive wheels (front / rear)		2 / 1
3.6	Front wheel gauge	b10	2072 mm
<b>Dimensions</b>			
4.2	Height telescopic boom lowered	h1	2285 mm
4.3	Mast free lift	h2	1700 mm
4.4	Max. lifting height	h3	3415 mm
4.5	Height telescopic boom extended	h4	3915 mm
4.7	Height of overhead guard (cabin)	h6	2203 mm
4.19	Overall length	l1	2790 mm
4.21	Overall width	b1	2348 mm
4.22	Forks section / width / length	s / e / l	40 mm x 122 mm x 1200 mm
4.23	Fork carriage ISO 2328 (class/form) A/B		2A
4.24	Fork carriage width	b3	1270 mm
4.26	Distance between wheel arms/loading surfaces	b4	1520 mm
4.28	Maximum horizontal extension at COG 600	l4	1310 mm
4.32	Ground clearance at centre of wheelbase	m2	290 mm
4.35	Turning radius	Wa	3072 mm
<b>Performances</b>			
5.1	Travel speed (laden / unladen)		11 km/h - 11 km/h
5.7	Gradeability (laden / unladen)		25 % / 35 %
5.10	Service brake		Hydraulic
	Transmission type		Hydrostatic
<b>Engine</b>			
7.1	Engine brand / norm / model		Kubota - China IV, Stage IIIB / V2403 M DI
7.2	Engine power (Hp / kW)		48.91 Hp / 36.50 kW
7.3	Rated speed		2700 rpm
7.4	Number of cylinders / Capacity of cylinders		4 - 2400 cm³
<b>Miscellaneous</b>			
8.2	Working hydraulic pressure for attachments		270 bar
8.3	Oil flow rate for attachments		50 l/min
8.4	Sound level at the driver's ear according to DIN 12 053		81 dB

### TMT-X 25 S K - Dimensional drawing



# TMT-X 25 S K - Load chart

## Machine on tires with forks Metric

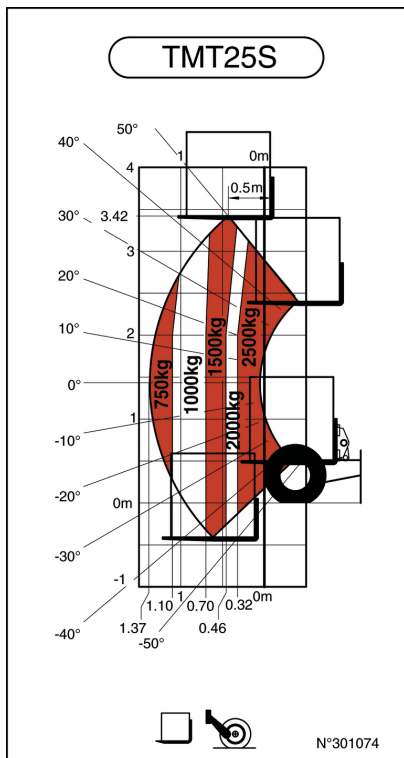

## Machine on lowered stabilisers with forks Metric

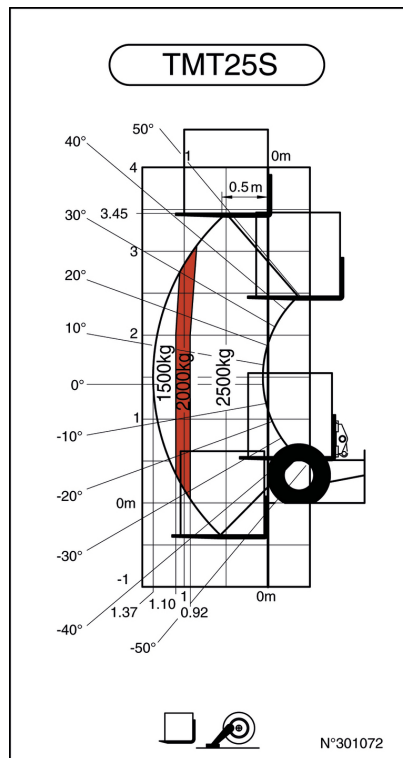

**Head Office**

B.P. 249 - 430 rue de l'Aubinière  
44150 Ancenis Cedex - France

Tel: +33 (0)2 40 09 10 11 - Fax: +33 (0)2 40 09 10 97

[www.manitou.com](http://www.manitou.com)



This publication provides a description of the configuration versions and options for Manitou products, which may differ for equipment. The equipment presented in this brochure may be part of a series, as an option, or it may not be available, depending on the versions. Manitou reserves the right, at any time and without notice, to amend the specifications described and represented. The specifications provided do not bind the manufacturer. For more details, please contact your Manitou agent. This is not a contractually binding document. The presentation of the products is not contractually binding. List of specifications non-exhaustive. The logos as well as the visual identity of the company are owned by Manitou and cannot be used without authorisation. All rights reserved. The photos and diagrams contained in this brochure are only provided for consultation and information purposes.

MANITOU BF SA - Limited company with board of directors - Share capital: 39,668,399 euros - 857 802 508 RCS Nantes