

Technical sheet :

ME 320 LIFT



Technical characteristics		Metric	
1.1	Manufacturer		Manitou
1.2	Model Name		ME 320 LIFT
1.3	Power source		Electrical - Lithium
1.4	Operator type		Seated
1.5	Max. capacity	Q	2000 kg
1.6	Load center of gravity	c	500 mm
1.8	Load distance, centre of drive axle to fork	x	364.50 mm
1.9	Wheelbase	y	1407 mm
	Standard mast reference of the machine		FVD 30
Weight			
2.1	Service weight		3200 kg
2.2	Weight on front axle (laden) / rear axle (laden)		4580 kg / 620 kg
2.3	Weight on front axle (Unladen) / rear axle (Unladen)		1365 kg / 1835 kg
Wheels			
3.1	Tires type		Solid tires
3.2	Dimensions of front wheels		200/50-10
3.3	Dimensions of rear wheels		15x4,5-8
3.5	Number of front wheels / rear wheels		2 / 1
3.5.2	Number of drive wheels		2
3.6	Front wheel gauge	b10	932 mm
3.7	Rear wheel gauge	b11	178 mm
Dimensions			
4.8	Seat height/stand height	h7	1120 mm
4.7	Height of overhead guard (cabin)	h6	2158 mm
4.12	Height of towing bar (coupling height)	h10	525 mm
4.19	Overall length	l1	2907 mm
4.20	Length to face of forks	l2	1987 mm
4.21	Overall width	b1	1153 mm
4.22.1	Forks width / length	e / l	40 mm x 100 mm
4.23	Fork carriage ISO 2328 (class/form) A/B		2A
4.24	Fork carriage width	b3	1000 mm
4.31	Ground clearance below mast	m1	100 mm
4.32	Ground clearance at centre of wheelbase	m2	110 mm
4.33	Aisle Width for pallets 1000 x 1200 crossways	Ast	3316 mm
4.34	Aisle width for 800 x 1200 pallet lengthways	Ast	3440 mm
4.35	Turning radius	Wa	1625 mm
Performances			
5.1	Travel speed (laden / unladen)		15 km/h-15 km/h
5.2	Lifting speed (laden / unladen)		0.40 m/s-0.55 m/s
5.3	Lowering speed (laden / unladen)		0.47 m/s-0.42 m/s
5.5	Drawbar pull (Laden / Unladen)		305 daN / 370 daN
5.7	Gradeability (laden / unladen)		5 % / 9 %
5.10	Service brake		Hydraulic
Engine			
6.1	Drive motor rating S2 60 min		2.50 kW
6.2	Lift motor rating at S3 15%		11 kW
6.3	Battery according to DIN 43531/35/36 A, B, C		Lithium
6.4	Battery voltage / capacity		76.80 V / 304 Ah
6.5	Battery weight (+/- 5%)		300 kg
6.6	Energy consumption according to VDI cycle (kWh/h)		4.60 kWh/h
Miscellaneous			
8.2	Working hydraulic pressure for attachments		210 bar
8.3	Oil flow rate for attachments		30 l/min
8.4	Sound level at the driver's ear according to DIN 12 053		70 dB

ME 320 LIFT - Dimensional drawing

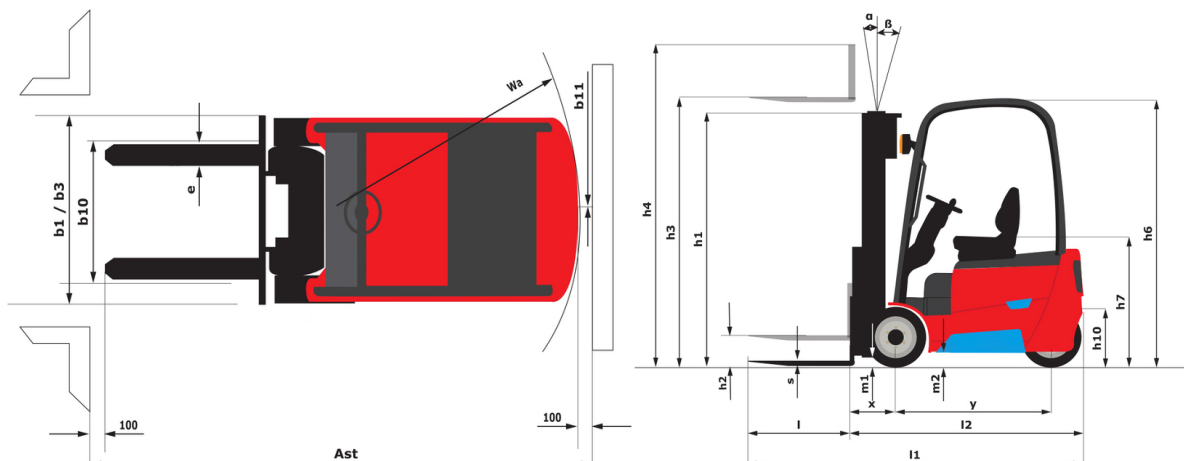

Characteristics of masts and residual capacities

Full Visibility Duplex (FVD)		FVD 30	FVD 33	FVD 40	FVD 45
α - Mast/fork carriage tilt, forward	°	7	7	7	7
β - Mast/fork carriage tilt, backward	°	6	6	6	6
h1 - Mast lowered height	mm	1988	2138	2588	2838
h2 - Mast free lift	mm	140	140	140	140
h3 - Mast lifting height	mm	3000	3300	4000	4500
h4 - Mast extended height	mm	3560	3860	4560	5060
Residual capacity at max height	kg	2000	2000	2000	1900
Residual capacity with integrated side shift at max height	kg	1950	1950	1950	1850

Free Lift Triplex (FLT)		FLT 40	FLT 45	FLT 48	FLT 50	FLT 55	FLT 60	FLT 65
α - Mast/fork carriage tilt, forward	°	3.50	3.50	3.50	3.50	3.50	3.50	3.50
β - Mast/fork carriage tilt, backward	°	5	5	5	5	5	5	5
h1 - Mast lowered height	mm	1888	2038	2138	2213	2388	2588	2788
h2 - Mast free lift	mm	1292	1392	1492	1592	1792	1992	2192
h3 - Mast lifting height	mm	4000	4500	4800	5000	5500	6000	6500
h4 - Mast extended height	mm	4552	5052	5352	5552	6052	6552	7052
Residual capacity at max height	kg	2000	1800	1700	1600	1500	1300	1100
Residual capacity with integrated side shift at max height	kg	1950	1750	1650	1550	1450	1250	1050



Head Office

B.P. 249 - 430 rue de l'Aubinière
44150 Ancenis Cedex - France

Tel: +33 (0)2 40 09 10 11 - Fax: +33 (0)2 40 09 10 97

www.manitou.com



This publication provides a description of the configuration versions and options for Manitou products, which may differ for equipment. The equipment presented in this brochure may be part of a series, as an option, or it may not be available, depending on the versions. Manitou reserves the right, at any time and without notice, to amend the specifications described and represented. The specifications provided do not bind the manufacturer. For more details, please contact your Manitou agent. This is not a contractually binding document. The presentation of the products is not contractually binding. List of specifications non-exhaustive. The logos as well as the visual identity of the company are owned by Manitou and cannot be used without authorisation. All rights reserved. The photos and diagrams contained in this brochure are only provided for consultation and information purposes.

MANITOU BF SA - Limited company with board of directors - Share capital: 39,668,399 euros - 857 802 508 RCS Nantes