

Technical sheet :

MI 25 D ST5 FOB



 **MANITOU**
HANDLING YOUR WORLD

Technical characteristics			Metric
1.1	Manufacturer		MANITOU
1.2	Model Name		MI 25 D ST5 FOB
1.3	Power source		Diesel
1.4	Operator type		Seated
1.5	Max. capacity	Q	2500 kg
1.6	Load center of gravity	c	500 mm
1.8	Load distance, centre of drive axle to fork	x	465 mm
1.9	Wheelbase	y	1600 mm
Weight			
2.1	Service weight		4000 kg
2.2	Weight on front axle (laden) / rear axle (laden)		5735 kg / 765 kg
2.3	Weight on front axle (Unladen) / rear axle (Unladen)		1710 kg / 2290 kg
Wheels			
3.1	Tires type		Solid tires
3.2	Dimensions of front wheels		7.00-12 12
3.3	Dimensions of rear wheels		6.00-9 10
3.5	Number of front wheels / rear wheels		2 / 2
3.5.2	Number of drive wheels		2
3.6	Front wheel gauge	b10	965 mm
3.7	Rear wheel gauge	b11	973 mm
Dimensions			
4.8	Seat height/stand height	h7	1190 mm
4.7	Height of overhead guard (cabin)	h6	2115 mm
4.12	Height of towing bar (coupling height)	h10	360 mm
4.19	Overall length	l1	3685 mm
4.20	Length to face of forks	l2	2535 mm
4.21	Overall width	b1	1155 mm
4.21	Overall width - Single wheels	b1	1155 mm
4.21	Overall width - Twinned wheels	b1	1595 mm
4.22	Forks section / width / length	s / e / l	40 mm x 122 mm x 1150 mm
4.23	Fork carriage ISO 2328 (class/form) A/B		2A
4.24	Fork carriage width	b3	1038 mm
4.31	Ground clearance below mast	m1	115 mm
4.32	Ground clearance at centre of wheelbase	m2	175 mm
4.33	Aisle Width for pallets 1000 x 1200 crossways	Ast	3930 mm
4.34	Aisle width for 800 x 1200 pallet lengthways	Ast	4130 mm
4.35	Turning radius	Wa	2265 mm
4.36	Internal turning radius (over tyres)	b13	145 mm
Performances			
5.1	Travel speed (laden / unladen)		18 km/h-18.50 km/h
5.2	Lifting speed (laden / unladen)		0.60 m/s-0.65 m/s
5.3	Lowering speed (laden / unladen)		0.50 m/s-0.55 m/s
5.5	Drawbar pull (Laden / Unladen)		1940 daN / 1240 daN
5.7	Gradeability (laden / unladen)		20 % / 20 %
5.10	Service brake		Hydraulic
Engine			
7.1	Engine brand / model / nom		Kubota / V2607-CR-E5B / Stage V
7.2	Engine power (Hp / kW)		51 Hp/37.40 kW
7.3	Rated speed		2400 rpm
7.4	Number of cylinders / Capacity of cylinders		4 - 2615 cm³
Miscellaneous			
8.2	Working hydraulic pressure for attachments		160 bar
8.3	Oil flow rate for attachments		35 l/min
8.4	Measured/guaranteed mean noise level at the ear of the operator		< 84 dB

MI 25 D ST5 FOB - Dimensional drawing

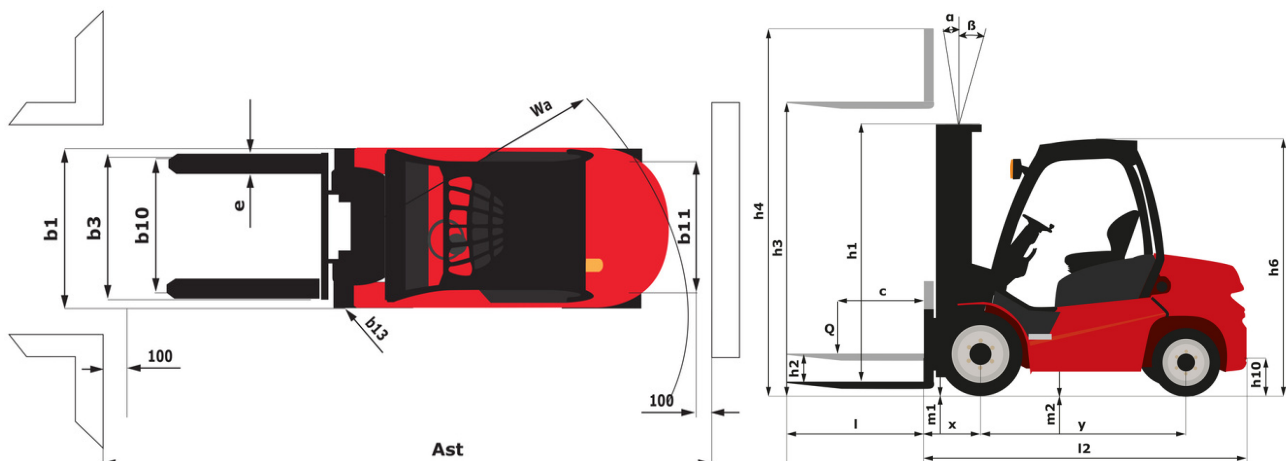



Head Office

B.P. 249 - 430 rue de l'Aubinière
44150 Ancenis Cedex - France

Tel: +33 (0)2 40 09 10 11 - Fax: +33 (0)2 40 09 10 97

www.manitou.com



This publication provides a description of the configuration versions and options for Manitou products, which may differ for equipment. The equipment presented in this brochure may be part of a series, as an option, or it may not be available, depending on the versions. Manitou reserves the right, at any time and without notice, to amend the specifications described and represented. The specifications provided do not bind the manufacturer. For more details, please contact your Manitou agent. This is not a contractually binding document. The presentation of the products is not contractually binding. List of specifications non-exhaustive. The logos as well as the visual identity of the company are owned by Manitou and cannot be used without authorisation. All rights reserved. The photos and diagrams contained in this brochure are only provided for consultation and information purposes.

MANITOU BF SA - Limited company with board of directors - Share capital: 39,668,399 euros - 857 802 508 RCS Nantes