

Technical sheet :

MRT 2260 E

OXYGEN



 **MANITOU**
HANDLING YOUR WORLD

| Capacities | | Metric |
|---|-----------|--|
| Max. capacity | | 6000 kg |
| Max. lifting height | | 21.80 m |
| Max. outreach | | 18.20 m |
| Weight and dimensions | | |
| Overall length (with forks) | l1 | 8.17 m |
| Length to face of forks | l2 | 6.97 m |
| Overall width | b1 | 2.50 m |
| Overall height | h17 | 3.10 m |
| Overall cab width | b4 | 0.96 m |
| Ground clearance | m4 | 0.38 m |
| Wheelbase | y | 3.05 m |
| Tilt-up angle | a4 | 12 ° |
| Tilt-down angle | a5 | 110 ° |
| Turret rotation | | 360 ° |
| Overall weight | | 18000 kg |
| Forks length / width / section | l / e / s | 100 mm x 1200 mm x 60 mm |
| Wheels | | |
| Standard tires | | 445/65 R22,5 |
| Drive wheels (front / rear) | | 2 / 2 |
| Steering mode | | 2 wheel steer, 4 wheel steer, Crab mode |
| Stabilisers | | |
| Stabilizers Type | | Telescopic Duplex |
| Controls with stabs | | Stabs Commands Individual or Simultaneous |
| Electric circuit | | |
| Number of batteries / Battery voltage | | 2 x 12 V |
| 12V Battery capacity | | 120 Ah |
| Battery starting current | | (EN)850 A |
| Engine/Battery | | |
| Battery technology | | Lithium-ion |
| Battery capacity | | 105 Ah |
| Battery nominal voltage | | 624 V |
| Battery max. voltage | | 680 V |
| Battery energy | | 65 kWh |
| Electric engine power rating | | 107 kW |
| Hydraulic motor power | | 84 kW |
| Charger Power / Phase / Current type | | 11 kW / Single-phase or three-phase / AC |
| Transmission | | |
| Transmission type | | Electrical |
| Number of gears (forward / reverse) | | 2 / 2 |
| Max. travel speed | | 37 km/h |
| Drawbar pull | | 8600 daN |
| Drawbar pull continuous | | 4300 daN |
| Parking brake | | Automatic negative parking brake |
| Service brake | | Oil-immersed multi-discs braking on front & rear axles |
| Performances | | |
| Max Gradeability (laden / unladen) | | 36 % / 48 % |
| Gradeability continuous (laden / unladen) | | 18 % / 23 % |
| Hydraulics | | |
| Hydraulic pump type | | Fixed displacement piston |
| Hydraulic flow | | 175 l/min |
| Hydraulic Pressure | | 350 bar |
| Hydraulic tank capacity | | 200 l |
| Noise and vibration | | |
| Noise at driving position (LpA) | | 65 dB |
| Noise to environment (LwA) | | 103 dB |
| Vibration on hands/arms | | < 2.50 m/s ² |
| Miscellaneous | | |
| Steering wheels (front / rear) | | 2 / 2 |
| Controls | | 2 Joysticks |
| Safety cab homologation | | Cabin ROPS - FOPS level 2 |
| Attachment recognition system (E-Reco) | | Standard |

MRT 2260 e - Dimensional drawing

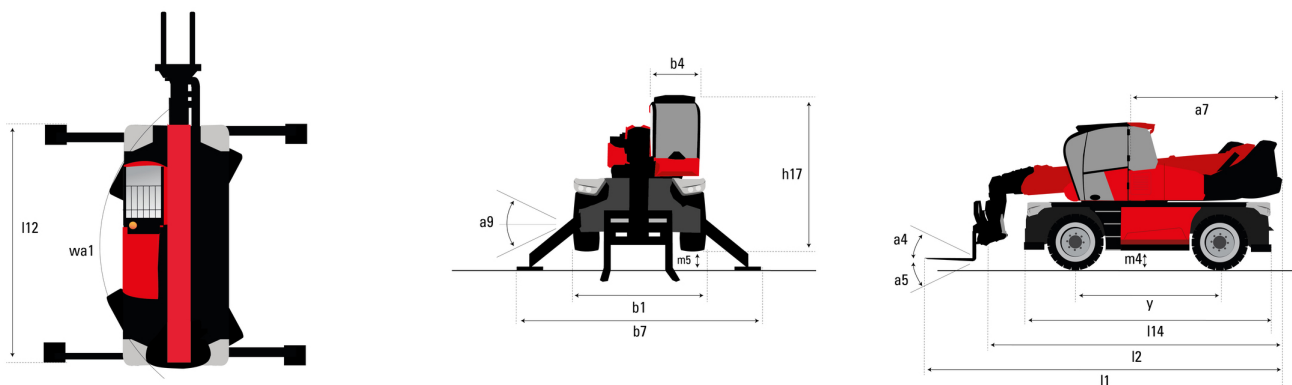

| Other data | | Metric |
|---|-----|--------|
| Length of frame | l14 | 5.69 m |
| Wheelbase | y | 3.05 m |
| Ground clearance | m4 | 0.38 m |
| Counterweight offset (turret at 90°) | a7 | 2.97 m |
| Tilt-up angle | a4 | 12° |
| Tilt-down angle | a5 | 110° |
| Overall length at stabilisers | l12 | 5.30 m |
| External turning radius (over tyres) | Wa1 | 4.46 m |
| Overall width with stabilisers extended | b7 | 5.79 m |
| Overall height | h17 | 3.10 m |
| Frame leveling corrector | a9 | +/- 7° |
| Ground clearance under front tires on stabilizers | m5 | 0.43 m |

MRT 2260 e - Load chart

Machine on tires with forks Metric



Machine on lowered stabilisers with forks (CAF) Metric



Machine on lowered stabilisers with winch 6000 kg (Metric) Machine on lowered stabilisers with 1500 kg jib with winch (Metric)

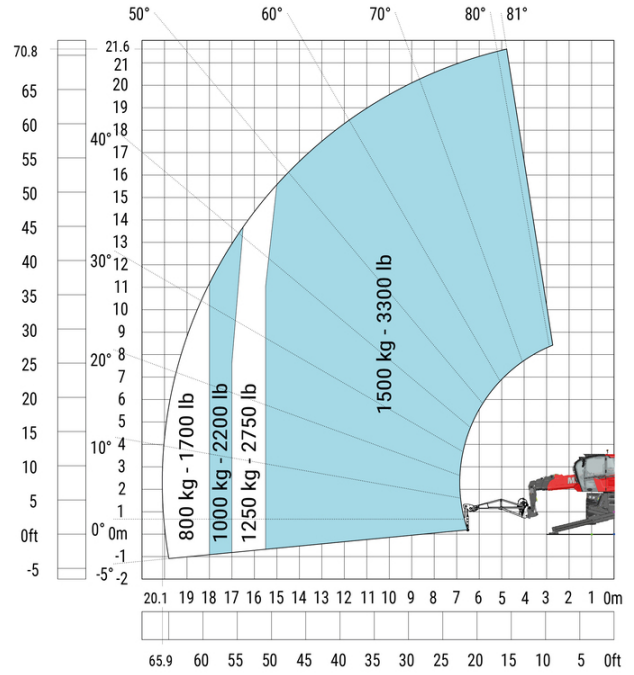

Machine on lowered stabilisers with extensible jib with winch (Metric)



Machine on lowered stabilisers with hook 6000 kg (Metric)



Machine on lowered stabilisers with 365 kg platform Metric Machine on lowered stabilisers with 1000 kg platform Metric



Machine on lowered stabilisers with 3D positive Metric

Machine on lowered stabilisers with 3D positive / negative Metric



Equipment

Optional

Additional battery high voltage 65 kWh

Extra generator 18.4 kW

Equipment: E-xtra generator 18.4 kW

| Engine | | Metric |
|---|--|---------------------------|
| Engine brand / norm | | Yanmar / Stage V / Tier 4 |
| Engine model | | 3TNV80F-ZXKMU |
| Number of cylinders - Capacity of cylinders | | 3 - 1267 cm ³ |
| Max. torque / Engine rotation (min) | | 74.50 Nm @ 1900 rpm |
| Power | | 18.40 kW |
| Engine rotation | | 2800 rpm |
| Engine cooling system | | Water cooled |
| I.C. Engine power rating | | 25 Hp |
| Tank capacities | | |
| Fuel tank | | 65 l |
| Engine oil | | 3.40 l |



Head Office

B.P. 249 - 430 rue de l'Aubinière

44150 Ancenis Cedex - France

Tel: +33 (0)2 40 09 10 11 - Fax: +33 (0)2 40 09 10 97

www.manitou.com



This publication provides a description of the configuration versions and options for Manitou products, which may differ for equipment. The equipment presented in this brochure may be part of a series, as an option, or it may not be available, depending on the versions. Manitou reserves the right, at any time and without notice, to amend the specifications described and represented. The specifications provided do not bind the manufacturer. For more details, please contact your Manitou agent. This is not a contractually binding document. The presentation of the products is not contractually binding. List of specifications non-exhaustive. The logos as well as the visual identity of the company are owned by Manitou and cannot be used without authorisation. All rights reserved. The photos and diagrams contained in this brochure are only provided for consultation and information purposes.

MANITOU BF SA - Limited company with board of directors - Share capital: 39,668,399 euros - 857 802 508 RCS Nantes