

Fiche technique :

MRT 2660 E

OXYGEN



 **MANITOU**
HANDLING YOUR WORLD

Capacities		Métrique
Max. capacity		6000 kg
Max. lifting height		25.90 m
Max. outreach		21.70 m
Weight and dimensions		
Overall length (with forks)	l1	9.28 m
Length to face of forks	l2	8.08 m
Overall width	b1	2.50 m
Overall height	h17	3.10 m
Overall cab width	b4	0.96 m
Ground clearance	m4	0.38 m
Wheelbase	y	3.05 m
Tilt-up angle	a4	12 °
Tilt-down angle	a5	110 °
Turret rotation		360 °
Overall weight		18000 kg
Forks length / width / section	l / e / s	100 mm x 1200 mm x 60 mm
Wheels		
Standard tires		445/65 R22,5
Drive wheels (front / rear)		2 / 2
Steering mode		2 wheel steer, 4 wheel steer, Crab mode
Stabilisers		
Stabilizers Type		Telescopic Duplex
Controls with stabs		Stabs Commands Individual or Simultaneous
Electric circuit		
Number of batteries / Battery voltage		2 x 12 V
12V Battery capacity		120 Ah
Battery starting current		(EN)850 A
Engine/Battery		
Battery technology		Lithium-ion
Battery capacity		105 Ah
Battery nominal voltage		624 V
Battery max. voltage		680 V
Battery energy		65 kWh
Electric engine power rating		107 kW
Hydraulic motor power		84 kW
Charger Power / Phase / Current type		11 kW / Single-phase or three-phase / AC
Transmission		
Transmission type		Electrical
Number of gears (forward / reverse)		2 / 2
Max. travel speed		37 km/h
Drawbar pull		8600 daN
Drawbar pull continuous		4300 daN
Parking brake		Automatic negative parking brake
Service brake		Oil-immersed multi-discs braking on front & rear axles
Performances		
Max Gradeability (laden / unladen)		36 % / 48 %
Gradeability continuous (laden / unladen)		18 % / 23 %
Hydraulics		
Hydraulic pump type		Fixed displacement piston
Hydraulic flow		175 l/min
Hydraulic Pressure		350 bar
Hydraulic tank capacity		200 l
Noise and vibration		
Noise at driving position (LpA)		65 dB
Noise to environment (LwA)		103 dB
Vibration on hands/arms		< 2.50 m/s ²
Miscellaneous		
Steering wheels (front / rear)		2 / 2
Controls		2 Joysticks
Safety cab homologation		Cabin ROPS - FOPS level 2
Attachment recognition system (E-Reco)		Standard

MRT 2660 e - Schémas d'encombrement

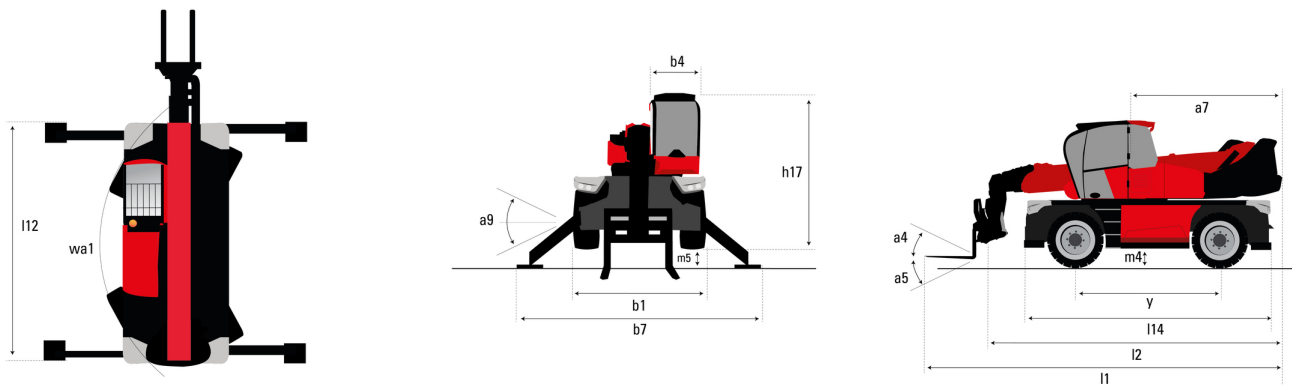

Autres données			Métrique
Length of frame		l14	5.69 m
Wheelbase		y	3.05 m
Ground clearance		m4	0.38 m
Counterweight offset (turret at 90°)		a7	2.97 m
Tilt-up angle		a4	12 °
Tilt-down angle		a5	110 °
Overall length at stabilisers		l12	5.30 m
External turning radius (over tyres)		Wa1	4.46 m
Overall width with stabilisers extended		b7	5.79 m
Overall height		h17	3.10 m
Frame leveling corrector		a9	+/- 7 °
Ground clearance under front tires on stabilizers		m5	0.43 m

MRT 2660 e - Abaques

Machine on tires with forks Metric

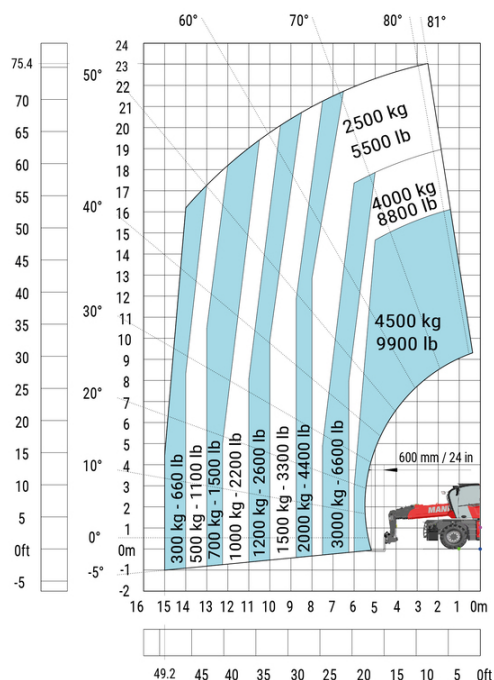

Machine on lowered stabilisers with forks (CAF) Metric

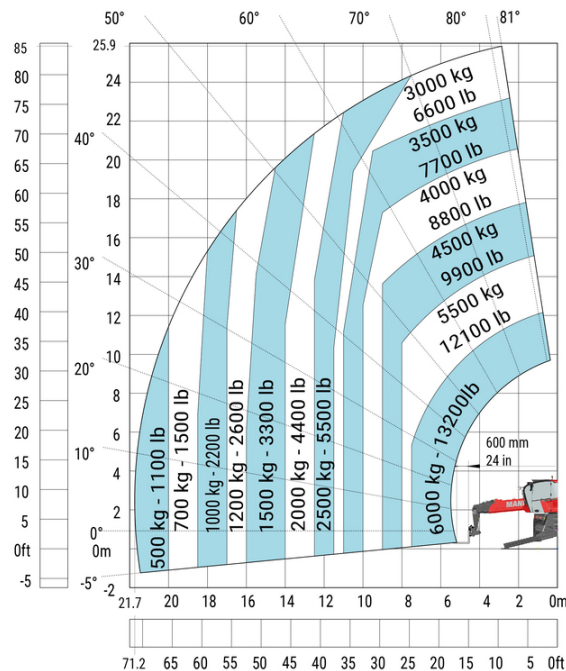

Machine on lowered stabilisers with 365 kg platform Metric Machine on lowered stabilisers with 1000 kg platform Metric

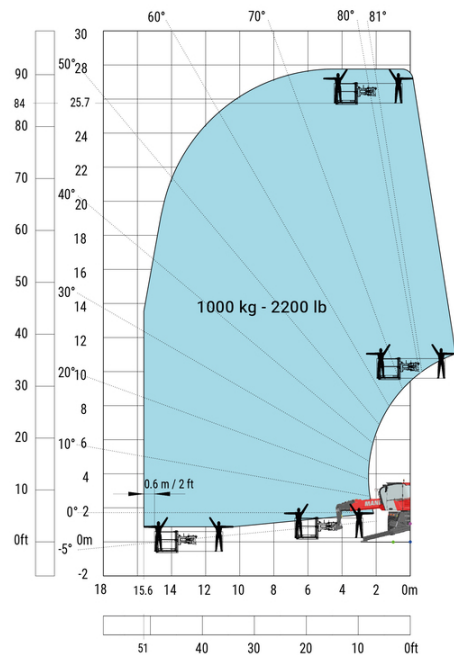
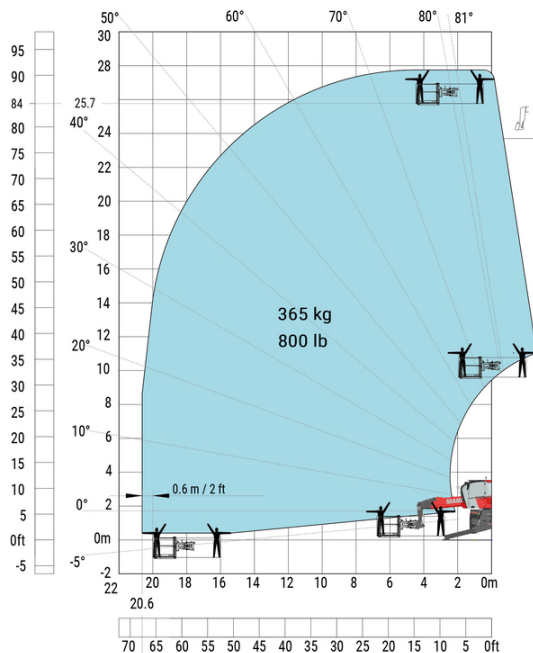

Machine on lowered stabilisers with 3D positive Metric

Machine on lowered stabilisers with 3D positive / negative Metric

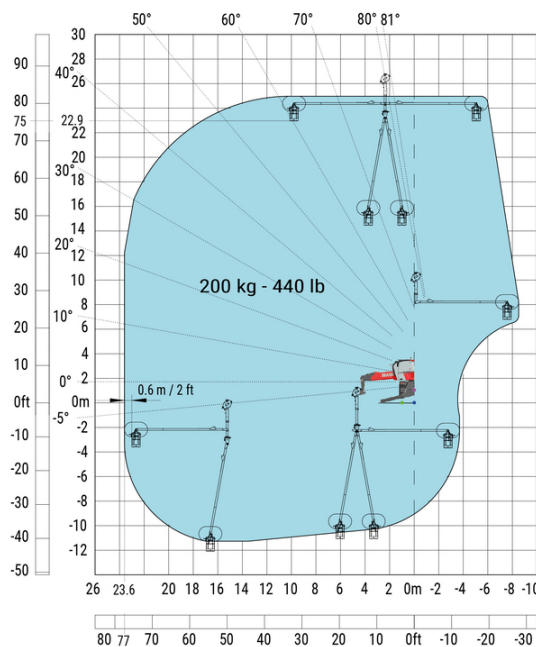
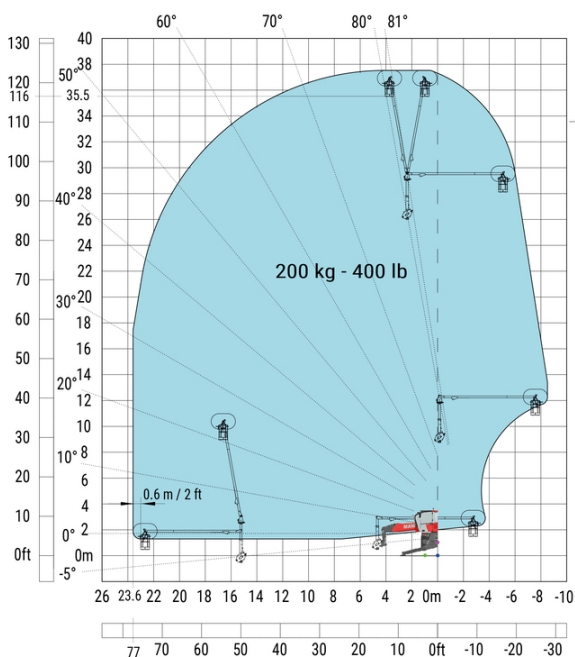

Équipements

Optionnel

Additional battery high voltage 65 kWh

E-xtra generator 18.4 kW

Équipement : E-xtra generator 18.4 kW

Engine		Métrique
Engine brand / norm		Yanmar / Stage V / Tier 4
Engine model		3TNV80F-ZXKMU
Number of cylinders - Capacity of cylinders		3 - 1267 cm ³
Max. torque / Engine rotation (min)		74.50 Nm @ 1900 rpm
Power		18.40 kW
Engine rotation		2800 rpm
Engine cooling system		Water cooled
I.C. Engine power rating		25 Hp
Tank capacities		
Fuel tank		65 l
Engine oil		3.40 l



 **MANITOU**
HANDLING YOUR WORLD

Siège Social

B.P. 249 - 430 rue de l'Aubinière

44150 Ancenis Cedex - France

Tel: +33 (0)2 40 09 10 11 - Fax: +33 (0)2 40 09 10 97

www.manitou.com



Cette publication présente le descriptif des versions et possibilités de configuration des produits Manitou qui peuvent différer en équipement. Les équipements présentés dans cette brochure peuvent être de série, en option, ou non disponibles suivant les versions. Manitou se réserve le droit, à tout moment et sans préavis, de modifier les spécifications décrites et représentées. Les spécifications portées n'engagent pas le constructeur. Pour plus de détails, contactez votre concessionnaire Manitou. Document non contractuel. Présentation des produits non contractuelle. Liste des spécifications non exhaustive. Les logos ainsi que l'identité visuelle de l'entreprise sont la propriété de Manitou et ne peuvent être utilisés sans autorisation. Tous droits réservés. Les photos et schémas contenus dans la présente brochure ne sont fournis qu'à des fins de consultation et à titre indicatif.

Manitou BF SA - Société anonyme à conseil d'administration - Capital social : 39 668 399 euros - 857 802 508 RCS Nantes