

Технический паспорт ТЕХНИЧЕСКОЕ ОПИСАНИЕ :

MRT 2660 E

OXYGEN



 **MANITOU**
HANDLING YOUR WORLD

Грузоподъемность		Метрический
Номинальная грузоподъемность	Q	6000 kg
Максимальная высота подъема		25.90 m
Максимальный вылет		21.70 m
Вес и размеры		
Габаритная длина (с вилами)	l1	9.28 m
Длина до основания вил	l2	8.08 m
Общая ширина	b1	2.50 m
Общая высота	h17	3.10 m
Общая ширина кабины	b4	0.96 m
Радиус поворота (снаружи колеса)	Wa1	4.46 m
Дорожный просвет	m4	0.38 m
Колесная база	y	3.05 m
Угол опрокидывания	a4	12 °
Угол опрокидывания ковша	a5	110 °
Вращение башни		360 °
Общий вес		18000 kg
Длина вил / Ширина вил / Секция вил	l / e / s	100 mm x 1200 mm x 60 mm
Шины		
Стандартные шины		445/65 R22,5
Ведущие колеса (передние / задние)		2 / 2
Режим рулевого управления		2 ведущих колеса, 4 ведущих колеса, Крабовый ход
Аутригеры		
Тип стабилизаторов		Телескопические двухсекционные
Управление стабилизаторами		Управление одним или всеми стабилизаторами
Электрическая система		
Количество батарей / Батарея		2 x 12 V
12V Емкость аккумуляторной батареи		120 Ah
Стартовый ток аккумулятора		(EN)850 A
Двигатель/аккумулятор		
Тип аккумуляторной батареи		Lithium-ion
Емкость аккумуляторной батареи		105 Ah
Номинальное напряжение аккумуляторной батареи		624 V
Максимальное напряжение аккумуляторной батареи		680 V
Энергоемкость аккумуляторной батареи		65 kWh
Номинальная мощность электрического двигателя		107 kW
Мощность привода гидравлического мотора		84 kW
Мощность зарядного устройства / Фаза / Тип тока		11 kW / Однофазный или трехфазный / AC
Трансмиссия		
Тип трансмиссии		Электрическая
Количество передач (вперед / назад)		2 / 2
Максимальная скорость передвижения		37 km/h
Тяговое усилие		8600 daN
Тяга дышла непрерывная		4300 daN
Стояночный тормоз		Автоматический негативный стояночный тормоз
Рабочий тормоз		Погруженные в масло многодисковые тормоза на передней и задней оси
Производительность		
Преодолеваемый уклон – с грузом / без груза		36 % / 48 %
Проходимость непрерывная (с грузом) / Постоянная проходимость (без нагрузки)		18 % / 23 %
Гидравлика		
Тип гидравлического насоса		Поршень с фиксированным рабочим объемом
Гидравлический поток		175 l/min
Гидравлическое давление		350 bar
Емкость гидравлического бака		200 l
Шум и вибрация		
Уровень шума в кабине (LpA)		65 dB
Звуковая мощность (LwA)		103 dB
Вибрация на руки оператора		< 2.50 m/s ²
Разное		
Управляемые колеса (передние / задние)		2 / 2
Органы управления		2 джойстика
Сертификация кабины		Кабина ROPS - FOPS Уровень 2
Система распознавания навесного оборудования (E-Reco)		Стандартный

MRT 2660 e - габаритный чертеж



Другие данные		Метрический
Длина рамы	l14	5.69 m
Смещение противовеса башни (на 90°)	a7	2.97 m
Общая длина аутригеров	l12	5.30 m
Общая ширина с выдвинутыми аутригерами	b7	5.79 m
Регулятор выравнивания рамы	a9	+/- 7°
Дорожный просвет под передними шинами на аутригерах	m5	0.43 m

MRT 2660 e - Диаграмма нагрузки

Машина на колесах с вилами - метрическая система мер

Машина на опущенных аутригерах с вилами (CAF), метрическая система мер

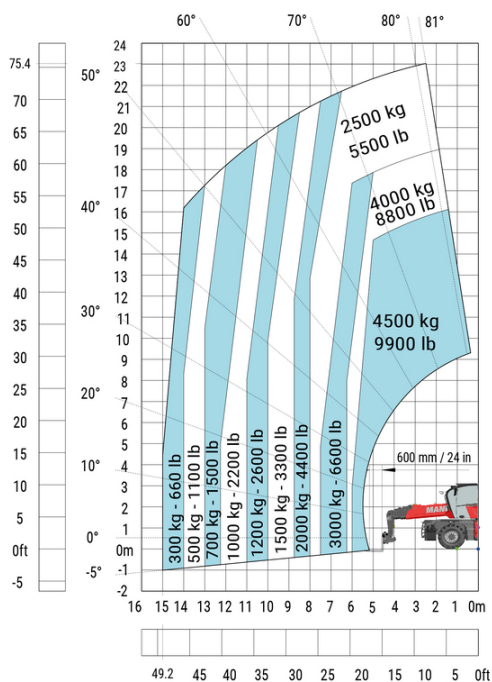

Машина на опущенных аутригерах с лебдкой 6000кг, метрическая система мер



Машина на опущенных аутригерах с кран-балкой с лебдкой 1500кг, метрическая система мер



Машина на опущенных аутригерах с выдвжной кран-балкой с лебдкой, метрическая система мер



Машина на опущенных аутригерах с крюком 6000кг, метрическая система мер



Машина при опущенных аутригерах с платформой 365 кг - метрическая система мер Машина при опущенных аутригерах с платформой 1000 кг - метрическая система мер

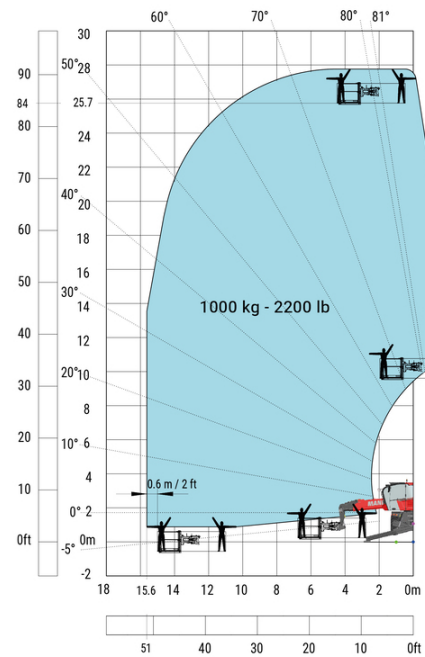

Вращение башни при опущенных аутригерах с 3D, в поднятом положении

Вращение башни при опущенных аутригерах с 3D, в поднятом/опущенном положении



Оборудование

Опционный

Генератор Extra 18,4 кВт

Дополнительная высоковольтная батарея 65 кВт·ч

Equipment: Генератор E-xtra 18,4 кВт

Двигатель		Метрический
Бренд двигателя / Экологический класс двигателя		Yanmar / Stage V / Tier 4
Модель двигателя		3TNV80F-ZXKMU
Мощность двигателя (л.с.)		25 Hp
Мощность двигателя (kW)		18.40 kW
Количество цилиндров - Объем цилиндров		3 - 1267 cm³
Максимальный крутящий момент / Обороты двигателя (мин)		74.50 Nm @ 1900 rpm
Крутящий момент двигателя		2800 rpm
Система охлаждения двигателя		Водяное охлаждение
Заправочные емкости		
Емкость топливного бака		65 l
Масло двигателя		3.40 l



MANITOU

HANDLING YOUR WORLD

Головной офис

В.Р. 249 - 430 rue de l'Aubinière

44150 Ancenis Cedex - France (Франция)

Телефон: 00 33 (0)2 40 09 10 11 - Факс: 00 33 (0)2 40 09 10 97

www.manitou.com



В данной брошюре описываются версии конфигурации и опции продуктов Manitou, которые могут отличаться в зависимости от оборудования. Описанное в данной брошюре оборудование может, в зависимости от версии, быть стандартным, опциональным или недоступным. Компания Manitou оставляет за собой право в любое время изменять приведенные и описанные характеристики без предварительного уведомления. Указанные технические характеристики не являются обязательными для производителя. Для получения дополнительной информации обратитесь к своему дилеру Manitou. Этот документ не имеет обязывающего, договорного характера. Описание продукции не имеет обязывающего, договорного характера. Список технических характеристик не является исчерпывающим. Логотипы и средства визуальной идентификации являются собственностью Manitou, их несанкционированное использование запрещено. Все права защищены. Фотографии и схемы в этой брошюре предоставлены только для ознакомления и в качестве справочной информации.

Manitou BF SA – Компания с ограниченной ответственностью и советом директоров – Акционерный капитал: 39 668 399 евро – Номер 857 802 508 в Реестре коммерсантов и предприятий Нанта