

Technical sheet :

80 VJR

OXYGEN
by MANITOU



 **MANITOU**
HANDLING YOUR WORLD

Capacities		Metric
Working height	h21	7.65 m
Platform height	h7	5.65 m
Max. outreach		3.20 m
Overhang		4.12 m
Pendular arm rotation (top / bottom)		+62 ° / 51 °
Platform capacity	Q	200 kg
Turret rotation		350 °
Number of people (indoor / outdoor)		2 / 1
Weight and dimensions		
Platform weight*		2410 kg
Platform dimensions (length x width)	lp / ep	1.19 m x 0.93 m
Floor height (access)	h20	0.41 m
Overall length	l1	2.95 m
Overall width	b1	0.99 m
Overall height	h17	1.99 m
Jib length	l13	1.61 m
Counterweight offset (turret at 90°)	a7	0.09 m
External turning radius	Wa3	2.10 m
Ground clearance under pothole protection	m6	0.03 m
Ground clearance at centre of wheelbase	m2	0.09 m
Wheelbase	y	1.20 m
Performances		
Drive speed - stowed		4.50 km/h
Drive speed - raised		0.65 km/h
Gradeability		25 %
Permissible leveling		2 °
Wheels		
Tires type		Non marking
Standard tires		16.5-11 1/4 / 406 x 127 mm
Drive wheels (front / rear)		0 / 2
Steering wheels (front / rear)		2 / 0
Braking wheels (front / rear)		0 / 2
Engine/Battery		
Electric engine power rating		2 x 0.77 kW
Lift motor power		3 kW
Number of hydraulic pump / Capacity of hydraulic pump		2 x 3.75 cm³
Battery voltage		24 V
Battery capacity		250 Ah
On-board charger (V / A)		24 V / 30 A
Miscellaneous		
Number of cycles with STD Battery (HIRD)		32
Ground Pressure		11.10 dan/cm2
Hydraulic Pressure		140 bar
Hydraulic tank capacity		22 l
Noise to environment (LwA)		< 70 dB
Vibration on hands/arms		< 0.50 m/s²
Standards compliance		
This machine is in compliance with:		European directives: 2006/42/EC- Machinery (revised EN280-1:2022) - 2004/108/EC (EMC) - 2006/95/EC (Low voltage)

*Varies according to options and standards of the country to which the machine is delivered

80 VJR - Load chart

Load Chart for MEWP Metric

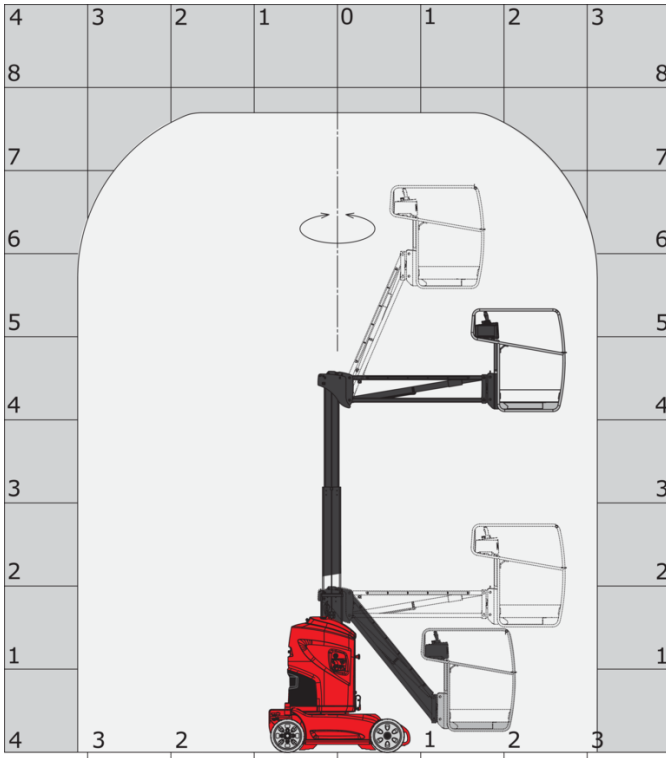

80 VJR - Dimensional drawing



Equipment

Standard

- Audible alarm and illuminated indicator lamp (leveling, overload, lowering)
- CAN bus technology
- Easy Link with 2 year Service
- Emergency stop button in platform and on frame
- Fixed pothole protection
- Fork pockets
- Hom in the platform
- Manual emergency lowering
- Multi-function smartview display
- Multi-voltage integrated charger
- Negative-type braking on rear wheels
- Non-marking rubber tyres
- Pendular arm
- Proportional controls
- Secondary Protection System (SPS)
- Slinging and securing rings
- Tool box in platform
- Traction battery
- Travel possible at maximum height
- lace floor basket

Optional

- 110 or 230V plug with differential circuit breaker
- Audio warning on all motion
- Audio warning on descent
- Audio warning on movement
- Biodegradable hydraulic oil - Grade 32
- Centralized filling of the battery
- Cold weather protection oil
- Easy Link - With access control keypad
- Easy link with remote lock
- LED strobe Light on the basket
- LED strobe light on the turret
- Maintenance-free battery
- Personalized paintwork
- Pre fitting electric supply IP65
- Protective cover for control panel
- Safety harness reminder indicator
- Safety kit - Harness + helmet
- Turret orientation information
- Working light (x1) on basket



Head Office

B.P. 249 - 430 rue de l'Aubinière

44150 Ancenis Cedex - France

Tel: +33 (0)2 40 09 10 11 - Fax: +33 (0)2 40 09 10 97

www.manitou.com



This publication provides a description of the configuration versions and options for Manitou products, which may differ for equipment. The equipment presented in this brochure may be part of a series, as an option, or it may not be available, depending on the versions. Manitou reserves the right, at any time and without notice, to amend the specifications described and represented. The specifications provided do not bind the manufacturer. For more details, please contact your Manitou agent. This is not a contractually binding document. The presentation of the products is not contractually binding. List of specifications non-exhaustive. The logos as well as the visual identity of the company are owned by Manitou and cannot be used without authorisation. All rights reserved. The photos and diagrams contained in this brochure are only provided for consultation and information purposes.

MANITOU BF SA - Limited company with board of directors - Share capital: 39,668,399 euros - 857 802 508 RCS Nantes