

Technical sheet :

# 100 VJR

OXYGEN  
by MANITOU



 **MANITOU**  
HANDLING YOUR WORLD

Capacities		Metric
Working height	h21	9.85 m
Platform height	h7	7.85 m
Max. outreach		3.10 m
Overhang		6.50 m
Pendular arm rotation (top / bottom)		+58 ° / -56 °
Platform capacity	Q	200 kg
Turret rotation		350 °
Number of people (indoor / outdoor)		2 / 1
Weight and dimensions		
Platform weight*		2820 kg
Platform dimensions (length x width)	lp / ep	1.19 m x 0.93 m
Floor height (access)	h20	0.46 m
Overall length	l1	2.80 m
Overall width	b1	0.99 m
Overall height	h17	1.99 m
Jib length	l13	1.45 m
Counterweight offset (turret at 90°)	a7	0.09 m
External turning radius	Wa3	2.02 m
Ground clearance under pothole protection	m6	0.03 m
Ground clearance at centre of wheelbase	m2	0.09 m
Wheelbase	y	1.20 m
Performances		
Drive speed - stowed		5 km/h
Drive speed - raised		0.65 km/h
Gradeability		25 %
Permissible leveling		2 °
Wheels		
Tires type		Non marking cushion
Standard tires		16.5-11 1/4 / 406 x 127 mm
Drive wheels (front / rear)		0 / 2
Steering wheels (front / rear)		2 / 0
Braking wheels (front / rear)		0 / 2
Engine/Battery		
Drive motor power rating		2 x 0.77 kW
Lift motor power		3 kW
Number of hydraulic pump / Capacity of hydraulic pump		2 x 3.75 cm <sup>3</sup>
Battery voltage		24 V
Battery capacity		250 Ah
On-board charger (V / A)		24 V / 30 A
Miscellaneous		
Number of cycles with STD Battery (HIRD)		29
Ground Pressure		11 daN/cm <sup>2</sup>
Hydraulic Pressure		140 bar
Hydraulic tank capacity		22 l
Vibration on hands/arms		< 0.50 m/s <sup>2</sup>
Standards compliance		
This machine is in compliance with:		European directives: 2006/42/EC- Machinery (revised EN280-1:2022) - 2004/108/EC (EMC) - EMC according to EN 12895 / 2015 +A1 / 2019

\*Varies according to options and standards of the country to which the machine is delivered

# 100 VJR - Load chart

## Load Chart for MEWP Metric



# 100 VJR - Dimensional drawing

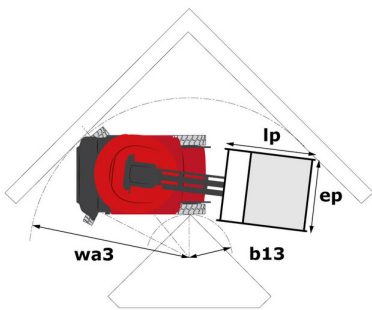

# Equipment

## Standard

Additional foot-operated hom  
Audible alarm and illuminated indicator lamp (leveling, overload, lowering)  
CAN bus technology  
Easy Link with 2 year Service  
Emergency stop button in platform and on frame  
Fixed pothole protection  
Fork pockets  
Manual emergency lowering  
Multi-function smartview display  
Multi-voltage onboard charger - 48V - 35A - ZIVAN - Gel - Single-phase  
Negative-type braking on rear wheels  
Non-marking rubber tyres  
Pendular arm  
Platform with open-work floor  
Proportional controls  
Secondary Protection System (SPS)  
Slings and securing rings  
Toolbox  
Traction battery

## Optional

Audio warning on all motion  
Audio warning on all motion  
Audio warning on descent  
Basket controls protection  
Basket with hinged doors  
Biodegradable hydraulic oil - Grade 32  
Central filling system  
Charger plug - 110V - 16A - United Kingdom (G) type  
Cold weather protection oil  
Easy Link - With access control keypad  
Easy Link - With remote lock  
Electrical pre-fitting - 230V - With IP65 reel  
Harness detection with a warning light  
LED amber strobe light on the basket  
LED strobe light on the turret  
LED work light - On basket  
Maintenance-free battery  
Personalized paintwork  
Safety kit - Helmet and harness  
Turret orientation detection



**Head Office**

B.P. 249 - 430 rue de l'Aubinière  
44150 Ancenis Cedex - France

Tel: +33 (0)2 40 09 10 11 - Fax: +33 (0)2 40 09 10 97

[www.manitou.com](http://www.manitou.com)



This publication provides a description of the configuration versions and options for Manitou products, which may differ for equipment. The equipment presented in this brochure may be part of a series, as an option, or it may not be available, depending on the versions. Manitou reserves the right, at any time and without notice, to amend the specifications described and represented. The specifications provided do not bind the manufacturer. For more details, please contact your Manitou agent. This is not a contractually binding document. The presentation of the products is not contractually binding. List of specifications non-exhaustive. The logos as well as the visual identity of the company are owned by Manitou and cannot be used without authorisation. All rights reserved. The photos and diagrams contained in this brochure are only provided for consultation and information purposes.

MANITOU BF SA - Limited company with board of directors - Share capital: 39,668,399 euros - 857 802 508 RCS Nantes