

Fiche technique :

100 VJR

OXYGEN
by MANITOU



 **MANITOU**
HANDLING YOUR WORLD

Capacités		Métrique
Hauteur de travail	h21	9.85 m
Hauteur de plate-forme	h7	7.85 m
Déport maximal		3.10 m
Surplomb		6.50 m
Rotation du bras pendulaire (haut / bas)		+58 ° / -56 °
Capacité de la nacelle	Q	200 kg
Rotation tourelle		350 °
Nombre de personnes (intérieur / extérieur)		2 / 1
Poids et dimensions		
Poids de la nacelle*		2820 kg
Longueur du panier x Largeur du panier	lp / ep	1.19 m x 0.93 m
Hauteur plancher (accès)	h20	0.46 m
Longueur hors-tout	l1	2.80 m
Largeur hors tout	b1	0.99 m
Hauteur hors tout	h17	1.99 m
Longueur pendulaire	l13	1.45 m
Déport du contrepoids (tourelle à 90°)	a7	0.09 m
Rayon de braquage extérieur	Wa3	2.02 m
Garde au sol sous plots stabilisateurs	m6	0.03 m
Garde au sol au centre de l'empattement	m2	0.09 m
Empattement	y	1.20 m
Performances		
Vitesse de translation - en mode transport		5 km/h
Vitesse de translation - en mode travail		0.65 km/h
Pente franchissable		25 %
Dévers autorisé		2 °
Roues		
Type de roues		Bandage non marquant
Pneus standards		16,5-11 1/4 / 406 x 127 mm
Roues motrices (avant / arrière)		0 / 2
Roues directrices (avant / arrière)		2 / 0
Freinage sur roues (avants / arrière)		0 / 2
Moteur/batterie		
Puissance du moteur électrique		2 x 0.77 kW
Puissance du moteur d'élévation		3 kW
Nombre de pompe hydraulique / Capacité de la pompe hydraulique		2 x 3.75 cm³
Tension batterie		24 V
Capacité de la batterie		250 Ah
Chargeur intégré (V / A)		24 V / 30 A
Divers		
Nombre de cycles avec batterie standard (HIRD)		29
Poinçonnage au sol		11 daN/cm2
Pression hydraulique		140 bar
Capacité du réservoir hydraulique		22 l
Vibration sur l'ensemble mains/bras		< 0.50 m/s²
Conformité aux normes		
Cette machine est conforme aux normes :		Directives européennes : 2006/42/CE- Machines (EN280-1 :2022 révisée) - 2004/108/CE (CEM) - CEM selon EN 12895 / 2015 +A1 / 2019

*Varie selon les options et les normes du pays dans lequel la machine est livrée.

100 VJR - Abaques

Abaque de charge pour nacelles métrique

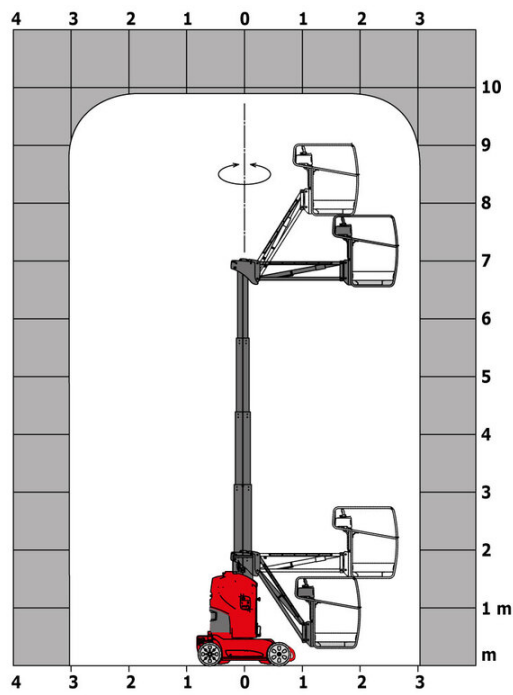

100 VJR - Schémas d'encombrement



Équipements

Standard

Alarme sonore et voyant lumineux (mise à niveau, surcharge, descente)

Anneaux de levage et d'arrimage

Batterie de traction

Bouton d'arrêt d'urgence sur la plateforme et sur le châssis

Boîte à outils

Bras pendulaire

Chargeur embarqué multi-voltage - 48V - 35A - ZIVAN - Gel - Monophasé

Commandes proportionnelles

Descente d'urgence manuelle

Easy Link avec Service 2 ans

Foureaux de fourche

Freinage de type négatif sur les roues arrière

Klaxon additionnel au pied

Plateforme avec plancher ajouré

Pneus en caoutchouc non marquants

Protection fixe contre les nids-de-poule

Système de protection secondaire (SPS)

Technologie CAN bus

Écran multifonction Smartview

Optionnel

Avertisseur sonore sur descente

Avertisseur sonore sur tous mouvements

Avertisseur sonore sur tous mouvements

Batterie sans entretien

Détection de hamais avec témoin lumineux

Détection orientation tourelle

Easy Link - Avec antidémarrage à distance

Easy Link - Avec contrôle d'accès par clavier

Feu à éclats orange LED au panier

Gyrophare LED sur la tourelle

Huile de protection pour grand froid

Huile hydraulique biodégradable - Grade 32

Kit de sécurité - Hamais et casque

Nacelle avec portes battantes

Peinture personnalisée

Phare de travail LED - Sur panier

Prise chargeur - 110V - 16A - Type Royaume-Uni (G)

Protection pupitre panier

Prédisposition électrique - 230V - Avec enrouleur IP65

Remplissage centralisé de batterie



Siège Social

B.P. 249 - 430 rue de l'Aubinière
44150 Ancenis Cedex - France

Tel: +33 (0)2 40 09 10 11 - Fax: +33 (0)2 40 09 10 97

www.manitou.com



Cette publication présente le descriptif des versions et possibilités de configuration des produits Manitou qui peuvent différer en équipement. Les équipements présentés dans cette brochure peuvent être de série, en option, ou non disponibles suivant les versions. Manitou se réserve le droit, à tout moment et sans préavis, de modifier les spécifications décrites et représentées. Les spécifications portées n'engagent pas le constructeur. Pour plus de détails, contactez votre concessionnaire Manitou. Document non contractuel. Présentation des produits non contractuelle. Liste des spécifications non exhaustive. Les logos ainsi que l'identité visuelle de l'entreprise sont la propriété de Manitou et ne peuvent être utilisés sans autorisation. Tous droits réservés. Les photos et schémas contenus dans la présente brochure ne sont fournis qu'à des fins de consultation et à titre indicatif.

Manitou BF SA - Société anonyme à conseil d'administration - Capital social : 39 668 399 euros - 857 802 508 RCS Nantes