

Technical sheet :

# EP 20P EASY



 **MANITOU**  
HANDLING YOUR WORLD

Technical characteristics		Metric	
1.1	Manufacturer		MANITOU
1.2	Model Name		EP 20P Easy
1.3	Power source		Electrical - Lead
1.4	Operator type		Carried
1.5	Max. capacity	Q	2000 kg
1.6	Load center of gravity	c	600 mm
1.8	Load distance, centre of drive axle to fork	x	940 mm
1.9	Wheelbase	y	1465 mm
Weight			
2.1	Service weight		785 kg
2.2	Weight on front axle (laden) / rear axle (laden)		1165 kg / 1760 kg
2.3	Weight on front axle (Unladen) / rear axle (Unladen)		610 kg / 175 kg
Wheels			
3.1	Tires type		Polyurethane cushion
3.2	Dimensions of front wheels		230 x 75
3.3	Dimensions of rear wheels		85 x 110
3.4	Number of stabilizer wheels / Size of the stabilizer wheels		2 / 125 x 50
3.5.2	Number of drive wheels / front wheels / rear wheels		1 / 3 / 2
3.6	Front wheel gauge	b10	575 mm
3.7	Rear wheel gauge	b11	370 mm
Dimensions			
4.15	Fork height in low position	h13	85 mm
4.19	Overall length	l1	1970 mm
4.19.1	Overall length (unfolded platform)	l1	2373 mm
4.20	Length to face of forks	l2	821 mm
4.21	Overall width	b1	809 mm
4.22	Forks section / width / length	s / e / l	64 mm x 170 mm x 1150 mm
4.25	Forks spread	b5	540 mm
4.32	Ground clearance at centre of wheelbase	m2	20 mm
4.33	Aisle Width for pallets 1000 x 1200 crossways	Ast	2596 mm
4.34	Aisle width for 800 x 1200 pallet lengthways	Ast	2646 mm
4.35	Turning radius	Wa	2186 mm
4.4	Mast lifting height	h3	125 mm
4.9	Height tiller min.	h14	1100 mm
4.9	Height tiller max.	h14	1419 mm
Performances			
5.1	Travel speed (laden / unladen)		7.50 km/h / 9.50 km/h
5.2	Lifting speed (laden / unladen)		0.03 m/s / 0.05 m/s
5.7	Gradeability (laden / unladen)		8 % / 16 %
5.10	Service brake		Electro magnetic
5.11	Parking brake		Handle Release
Engine			
6.1	Drive motor rating S2 60 min		1.50 kW
6.2	Lift motor rating at S3 15%		2.20 kW
6.3	Battery according to DIN 43531/35/36 A, B, C		DIN 43535-B
6.4	Battery voltage / capacity		24 V / 270 Ah
6.5	Battery weight (+/- 5%)		210 kg
Miscellaneous			
8.4	Measured/guaranteed mean noise level at the ear of the operator		< 65 dB

EP 20P Easy - Dimensional drawing

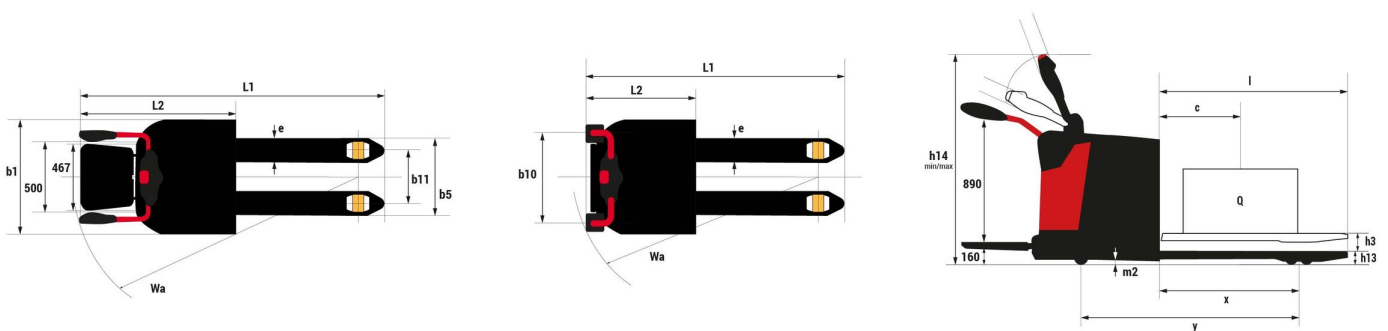

# Equipment

---

## Standard

Anti-crushing safety device

Emergency stop

Turtoise button



**Head Office**

B.P. 249 - 430 rue de l'Aubinière  
44150 Ancenis Cedex - France

Tel: +33 (0)2 40 09 10 11 - Fax: +33 (0)2 40 09 10 97

[www.manitou.com](http://www.manitou.com)



This publication provides a description of the configuration versions and options for Manitou products, which may differ for equipment. The equipment presented in this brochure may be part of a series, as an option, or it may not be available, depending on the versions. Manitou reserves the right, at any time and without notice, to amend the specifications described and represented. The specifications provided do not bind the manufacturer. For more details, please contact your Manitou agent. This is not a contractually binding document. The presentation of the products is not contractually binding. List of specifications non-exhaustive. The logos as well as the visual identity of the company are owned by Manitou and cannot be used without authorisation. All rights reserved. The photos and diagrams contained in this brochure are only provided for consultation and information purposes.

MANITOU BF SA - Limited company with board of directors - Share capital: 39,668,399 euros - 857 802 508 RCS Nantes