

Scheda tecnica :

ES-C 716



 **MANITOU**
HANDLING YOUR WORLD

Specifiche tecniche		Metrico	
1.1	Costruttore		Manitou
1.2	Nome modello		ES-C 716
1.3	Tipo di alimentazione		Elettrico - Piombo
1.4	Tipo di operatore		Integrativo
1.5	Portata massima	Q	1600 kg
1.6	Baricentro del carico	c	500 mm
1.8	Distanza dal piano forche al centro dell'assale posteriore	x	157 mm
1.9	Interasse	y	1300 mm
Weight			
2.1	Peso		2400 kg
2.2	Peso su assale anteriore (con carico) / posteriore (con carico)		520 kg / 3460 kg
2.3	Peso su assale anteriore a vuoto / posteriore a vuoto		1350 kg / 1050 kg
Pneumatici			
3.1	Tipo di ruote		Bandaggio in poliuretano
3.3	Numero di ruote portanti / Dimensione ruote portanti		2 / 250x100
3.5	Numero ruote anteriori / di ruote posteriori		1 / 2
3.5.2	Numero di ruote motrici / Dimensione ruote motrici		1/254x100
3.7	Ruota posteriore	b11	1003 mm
Dimensions			
4.15	Altezza delle forche in posizione abbassata	h13	45 mm
4.19	Lunghezza totale	l1	2790 mm
4.20	Lunghezza al piano forche	l2	1640 mm
4.21	Larghezza	b1	1120 mm
4.22	Sezione forche / Larghezza forche / Lunghezza forche	s / e / l	40 mm / 100 mm / 1150 mm
4.24	Larghezza della piastra portaforche	b3	750 mm
4.31	Altezza dal suolo sotto al montante	m1	31 mm
4.32	Altezza dal suolo al centro dell'interasse	m2	62 mm
4.33	Corridoio di lavoro con pallet 1000 x 1200 trasversale	Ast	3128 mm
4.34	Corridoio di lavoro con pallet 800 x 1200 longitudinale	Ast	3236 mm
4.35	Raggio di sterzata	Wa	1660 mm
4.9	Altezza del timone fino a min. / massima del timone	h14	1005 mm / 1405 mm
Performance			
5.1	Velocità di spostamento (con carico / senza carico)		6 km/h / 6 km/h
5.2	Velocità di sollevamento (con carico / senza carico)		0.11 m/s / 0.20 m/s
5.3	Velocità discesa con carico / (senza carico)		0.22 m/s / 0.21 m/s
5.8	Pendenza max. - con carico / senza carico		5 % / 8 %
5.10	Freno di servizio		Elettromagnetico
Motore			
6.1	Potenza del motore di traslazione (S2 60 min)		2 kW
6.2	Potenza nominale motore di sollevamento a S3 15%		4 kW
6.3	Batteria in conformità con DIN 43531/35/36 A, B, C		DIN 43535-B
6.4	Batteria / Capacità batteria		24 V / 315 Ah
6.4.1	Capacità max batteria		315 Ah
6.5	Peso batteria (+/- 5%)		275 kg
6.5.1	Peso max batteria		300 kg
Varie			
8.1	Tipo di unità motrice		AC
8.4	Livello di rumore all'orecchio del conducente secondo la norma DIN 12 053		65 dB

ES-C 716 - Disegno quotato

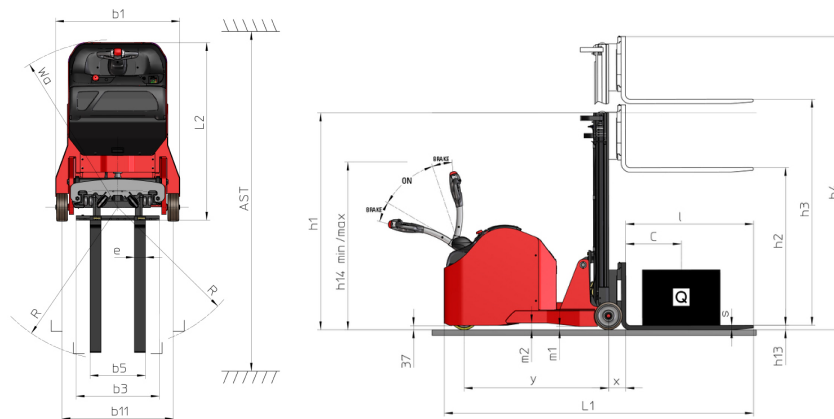

Caratteristiche dei montanti e capacità residue

Cilindro centrale simplex (CCS)		CCS 15	CCS 17
α - Inclinazione del montante e del portaforche, in avanti	°	4	4
β - Inclinazione del montante e del portaforche, indietro	°	6	6
h1 - Altezza montante abbassato	mm	1955	2205
h2 - Alzata libera	mm	1420	1670
h3 - Altezza di sollevamento	mm	1500	1700
h4 - Altezza montante sollevato	mm	2030	2280
Capacità residua all'altezza max	kg	1600	1600

Duplex Visibilità Totale (FVD)		FVD 29	FVD 34	FVD 38
α - Inclinazione del montante e del portaforche, in avanti	°	3	3	3
h1 - Altezza montante abbassato	mm	1955	2205	2405
h3 - Altezza di sollevamento	mm	2900	3400	3800
h4 - Altezza montante sollevato	mm	3460	3960	4360
Capacità residua all'altezza max	kg	1600	1600	1250

Duplex ad alzata libera (FLD)		FLD 29	FLD 34
α - Inclinazione del montante e del portaforche, in avanti	°	4	4
β - Inclinazione del montante e del portaforche, indietro	°	6	6
h1 - Altezza montante abbassato	mm	1955	2205
h2 - Alzata libera	mm	1420	1670
h3 - Altezza di sollevamento	mm	2900	3400
h4 - Altezza montante sollevato	mm	3460	3960
Capacità residua all'altezza max	kg	1600	1600

Triplex a sollevamento libero (FLT)		FLT 42	FLT 47	FLT 54
α - Inclinazione del montante e del portaforche, in avanti	°	4	4	4
β - Inclinazione del montante e del portaforche, indietro	°	6	6	6
h1 - Altezza montante abbassato	mm	1915	2075	2315
h2 - Alzata libera	mm	1380	1540	1790
h3 - Altezza di sollevamento	mm	4200	4700	5400
h4 - Altezza montante sollevato	mm	4770	5250	5980
Capacità residua all'altezza max	kg	1050	850	650



 **MANITOU**
HANDLING YOUR WORLD

Sede centrale
MANITOU ITALIA Srl
Via Cristoforo Colombo 2, Loc. Cavazzona - 41013 CASTELFRANCO EMILIA (MO)
Tel: 059.95.98.11 - Fax 059.95.98.65
www.manitou.com



Questa pubblicazione presenta la descrizione delle versioni e delle possibilità di configurazione dei prodotti Manitou, che possono differire per attrezzature. Gli allestimenti presentati nel presente opuscolo possono essere di serie, optional o non disponibili, a seconda delle versioni. Manitou si riserva il diritto di modificare, in qualsiasi momento e senza alcun preavviso, le specifiche tecniche descritte e rappresentate. Le specifiche indicate non rappresentano alcun obbligo per il costruttore. Per maggiori dettagli, rivolgersi al proprio concessionario Manitou. Documento non contrattuale. Elenco delle specifiche non esaustivo. I loghi nonché l'identità visiva dell'azienda sono di proprietà di Manitou e non possono essere utilizzati senza autorizzazione. Tutti i diritti riservati. Le immagini e gli schemi contenuti nel presente opuscolo sono forniti esclusivamente a fini di consultazione e a titolo indicativo.

Manitou BF SA - Società anonima con consiglio di amministrazione. Capitale sociale: 39,668,399 euro - 857 802 508 RCS Nantes