

Technical sheet :

MHT-X 11250 ST3A



 **MANITOU**
HANDLING YOUR WORLD

Capacities		Metric
Max. capacity	Q	24999 kg
Load center of gravity	c	900 mm
Max. lifting height		10.60 m
Maximum outreach		6 m
Weight and dimensions		
Overall length	l1	8.92 m
Unladen weight (with forks)		32950 kg
Ground clearance	m4	0.47 m
Wheelbase	y	4.10 m
Length to face of forks	l2	7.12 m
Overall width	b1	2.80 m
Overall height	h17	3.07 m
Overall cab width	b4	0.95 m
Tilt-up angle	a4	10 °
Tilt-down angle	a5	106 °
External turning radius (over tyres)	Wa1	5.50 m
Forks length / width / section	l / e / s	1800 mm x 220 mm x 100 mm
Frame leveling corrector	a9	10 °
Wheels		
Standard tires		18.00 R25
Number of front wheels / rear wheels		2 / 2
Drive wheels (front / rear)		2 / 2
Steering mode		2 wheel steer, 4 wheel steer, Crab mode
Engine		
Engine brand		Yanmar
Engine nom		Stage IIIA
Engine model		4TN107TF-6SMU2
Number of cylinders / Capacity of cylinders		4 - 4567 cm³
Engine power (Hp / kW)		211 Hp / 155 kW
Max. torque / Engine rotation		805 Nm@1500 rpm
Engine cooling system		Water
Number of batteries		2
Battery voltage		12 V
Drawbar pull		20400 daN
Transmission		
Transmission type		Hydrostatic
Number of gears (forward / reverse)		2 / 2
Max. travel speed		25 km/h
Parking brake		Automatic negative parking brake
Service brake		Oil-immersed multi-discs braking on front & rear axles
Gradeability (laden / unladen)		31.50 % / 57.70 %
Hydraulics		
Hydraulic pump type		Variable displacement pump
Hydraulic flow - Pressure		286 l/min - 350 bar
Tank capacities		
Engine oil		13 l
Hydraulic oil		290 l
Fuel		315 l
Noise and vibration		
Noise to environment (LwA)		109 dB
Vibration on hands/arms		< 2.50 m/s²
Miscellaneous		
Cab certification		Cabin ROPS - FOPS level 2
Controls		JSM
Attachment recognition system (E-Reco)		Standard

MHT-X 11250 ST3A - Dimensional drawing

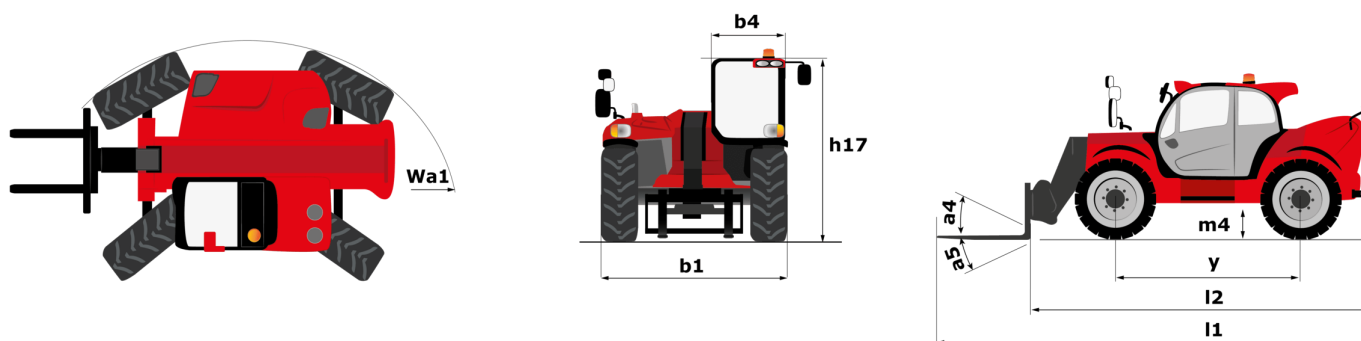

MHT-X 11250 ST3A - Load chart

Machine on tires with forks LC 900 mm Metric



Machine on tires with forks LC 1200 mm Metric



Machine on tires with winch 25000 kg (Metric)

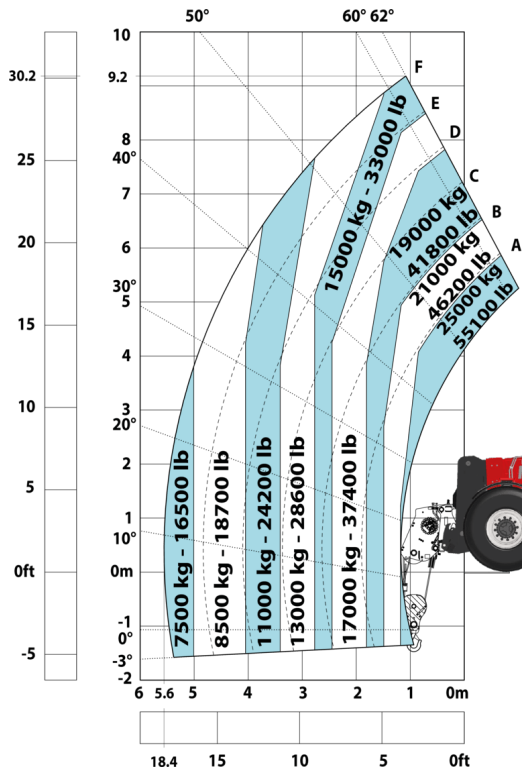

Machine on tires with 3-hook jib 25000 kg (Metric)



Machine on tires with tire handler TH 63 (Metric)



Machine on tires with cylinder handler CH 10 (Metric)





Head Office

B.P. 249 - 430 rue de l'Aubinière
44150 Ancenis Cedex - France

Tel: +33 (0)2 40 09 10 11 - Fax: +33 (0)2 40 09 10 97

www.manitou.com



This publication provides a description of the configuration versions and options for Manitou products, which may differ for equipment. The equipment presented in this brochure may be part of a series, as an option, or it may not be available, depending on the versions. Manitou reserves the right, at any time and without notice, to amend the specifications described and represented. The specifications provided do not bind the manufacturer. For more details, please contact your Manitou agent. This is not a contractually binding document. The presentation of the products is not contractually binding. List of specifications non-exhaustive. The logos as well as the visual identity of the company are owned by Manitou and cannot be used without authorisation. All rights reserved. The photos and diagrams contained in this brochure are only provided for consultation and information purposes.

MANITOU BF SA - Limited company with board of directors - Share capital: 39,668,399 euros - 857 802 508 RCS Nantes