

Technical sheet :

# **MRT-X 1645**

---

**VISION**



 **MANITOU**  
HANDLING YOUR WORLD

| Capacities                                  |           | Metric   |
|---|-----------|--|
| Max. capacity                               | Q         | 4500 kg  |
| Max. lifting height                         |           | 15.80 m  |
| Max. outreach                               |           | 13.50 m  |
| Weight and dimensions                       |           |  |
| Overall length (with forks)                 | l1        | 7.58 m   |
| Length to face of forks                     | l2        | 6.38 m   |
| Overall width                               | b1        | 2.42 m   |
| Overall height                              | h17       | 3.04 m   |
| Overall cab width                           | b4        | 0.96 m   |
| External turning radius (over tyres)        | Wa1       | 3.92 m   |
| Ground clearance                            | m4        | 0.37 m   |
| Wheelbase                                   | y         | 2.43 m   |
| Tilt-up angle                               | a4        | 12 °   |
| Tilt-down angle                             | a5        | 105 °  |
| Turret rotation                             |           | 400 °  |
| Overall weight                              |           | 13305 kg   |
| Forks length / width / section              | l / e / s | 1200 mm x 125 mm x 50 mm                               |
| Wheels                                      |           |  |
| Standard tires                              |           | 405/70-20  |
| Drive wheels (front / rear)                 |           | 2 / 2  |
| Steering mode                               |           | 2 wheel steer, 4 wheel steer, Crab mode                |
| Stabilisers                                 |           |  |
| Stabilizers Type                            |           | Wing Type  |
| Controls for stabs                          |           | Stabs Commands Individual or Simultaneous              |
| Engine                                      |           |  |
| Engine brand                                |           | Deutz  |
| Engine norm                                 |           | Stage IIIA   |
| Engine model                                |           | TCD 3.6 L4   |
| Engine power (Hp / kW)                      |           | 116 Hp / 85 kW   |
| Max. torque / Engine rotation (min)         |           | 460 Nm @ 1600 rpm                                      |
| Number of cylinders - Capacity of cylinders |           | 4 - 3620 cm³   |
| Engine cooling system                       |           | Water cooled   |
| Electric circuit                            |           |  |
| Number of batteries / Battery voltage       |           | 2 x 12 V   |
| 12V Battery capacity                        |           | 120 Ah   |
| Battery starting current                    |           | (EN) 850 A   |
| Transmission                                |           |  |
| Transmission type                           |           | Hydrostatic  |
| Number of gears (forward / reverse)         |           | 2 / 2  |
| Max. travel speed                           |           | 40 km/h  |
| Drawbar pull                                |           | 9700 daN   |
| Parking brake                               |           | Automatic negative parking brake                       |
| Service brake                               |           | Oil-immersed multi-discs braking on front & rear axles |
| Performances                                |           |  |
| Gradeability (laden / unladen)              |           | 46.60 % / 50.90 %                                      |
| Hydraulics                                  |           |  |
| Hydraulic pump type                         |           | Variable displacement pump                             |
| Hydraulic flow                              |           | 116 l/min  |
| Hydraulic Pressure                          |           | 275 bar  |
| Tank capacities                             |           |  |
| Engine oil                                  |           | 11 l   |
| Fuel tank capacity                          |           | 130 l  |
| Noise and vibration                         |           |  |
| Noise at driving position (LpA)             |           | 68 dB  |
| Noise to environment (LwA)                  |           | 106 dB   |
| Vibration on hands/arms                     |           | < 2.50 m/s²  |
| Miscellaneous                               |           |  |
| Steering wheels (front / rear)              |           | 2 / 2  |
| Controls                                    |           | 2 Joysticks  |
| Cab certification                           |           | Cabin ROPS - FOPS level 2                              |
| Attachment recognition system (E-Reco)      |           | Standard   |

### MRT-X 1645 - Dimensional drawing

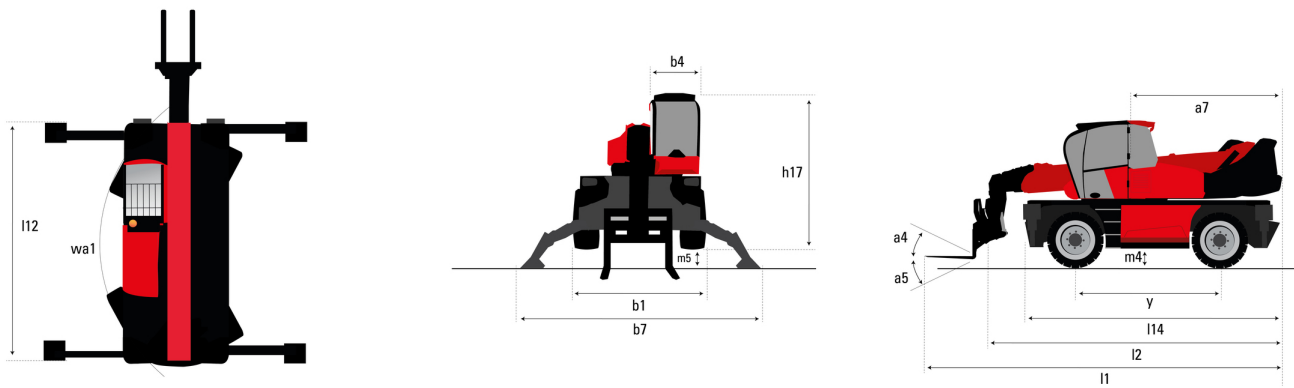

| Other data  |     | Metric |
|---|-----|--------|
| Length of frame                                   | l14 | 4.67 m |
| Counterweight offset (turret at 90°)              | a7  | 2.50 m |
| Overall length at stabilisers                     | l12 | 4.41 m |
| Overall width with stabilisers extended           | b7  | 4.01 m |
| Ground clearance under front tires on stabilizers | m5  | 0.18 m |

### MRT-X 1645 - Load chart

Machine on tires with forks Metric

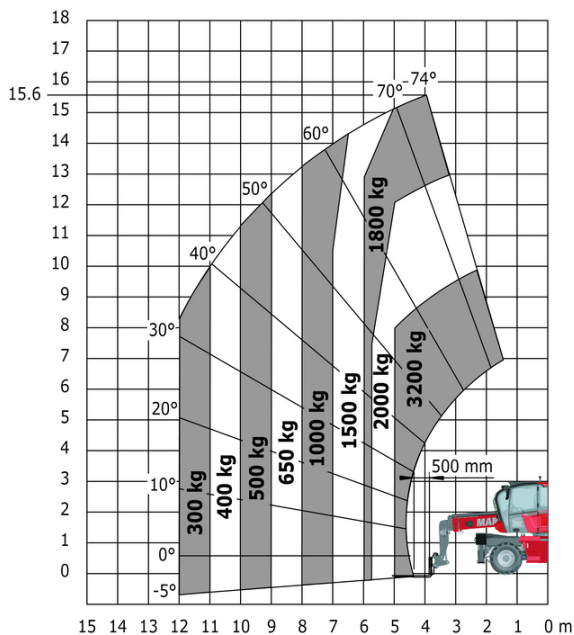

Machine on lowered stabilisers with forks Metric

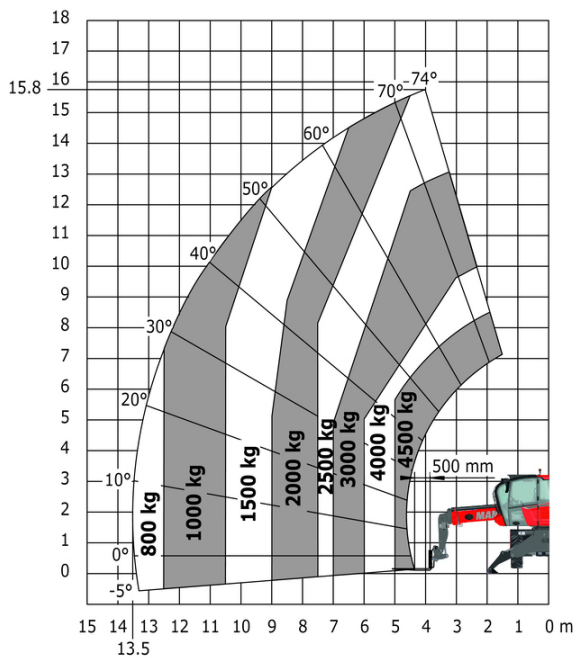

Machine on lowered stabilisers with winch 5000 kg Metric

Machine on lowered stabilisers with 4000 kg jib (Metric)

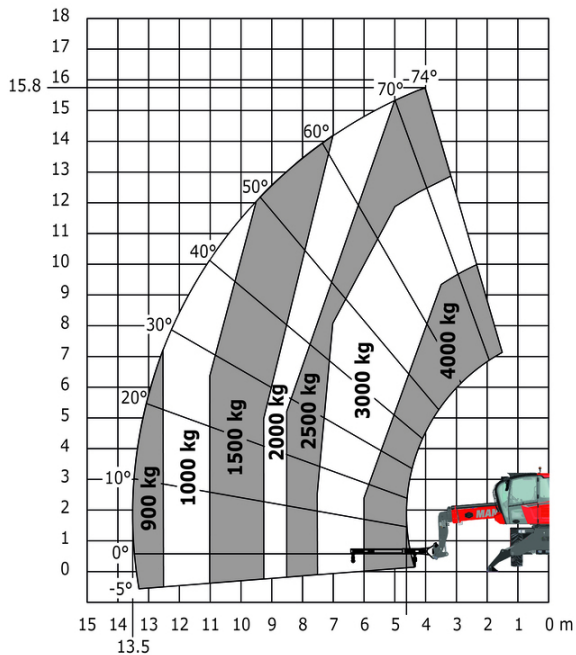
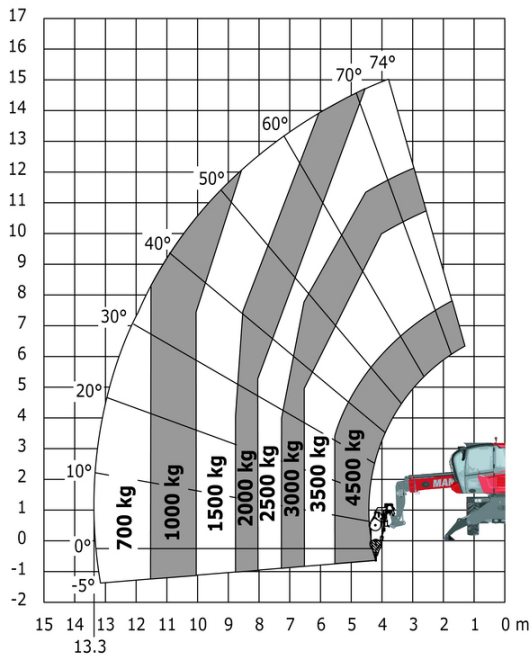

Machine on lowered stabilisers with 1500 kg jib with winch (Metric)

Machine on lowered stabilisers with hook 5000 kg (Metric)

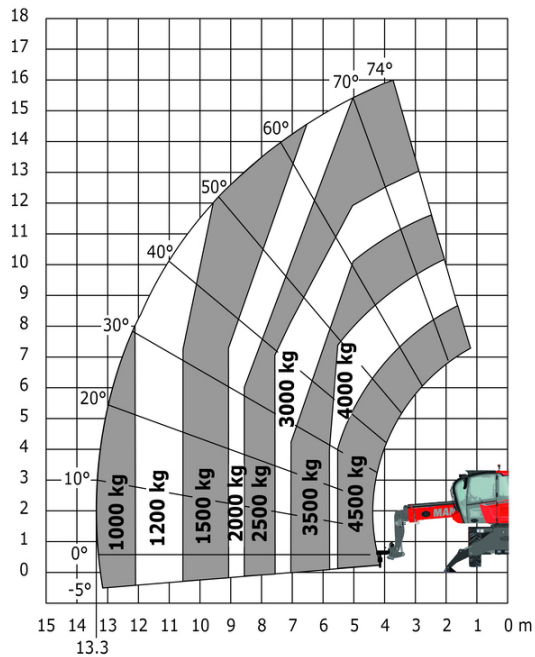
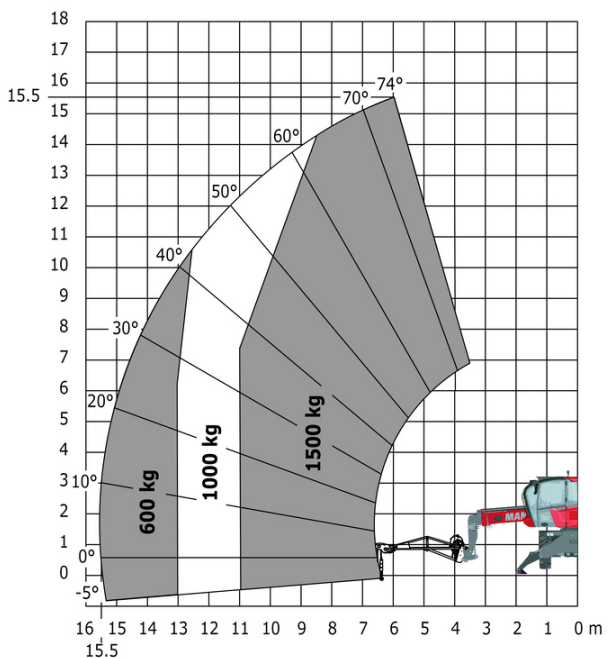

Machine on lowered stabilisers with 365 kg platform Metric Machine on lowered stabilisers with 1000 kg platform Metric

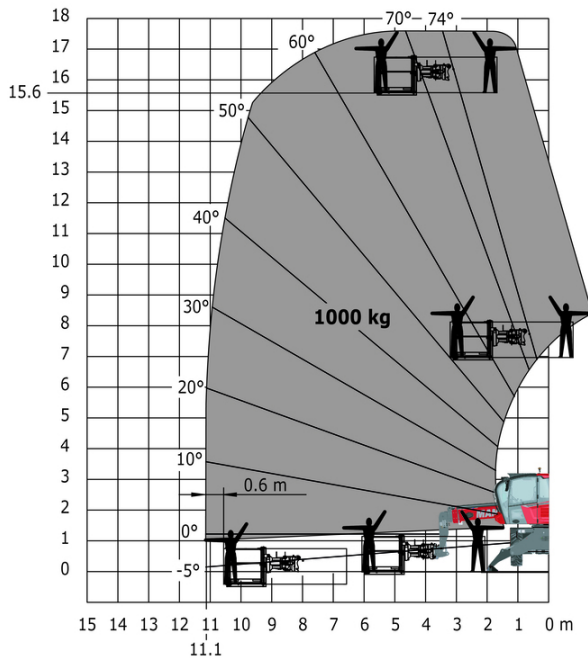
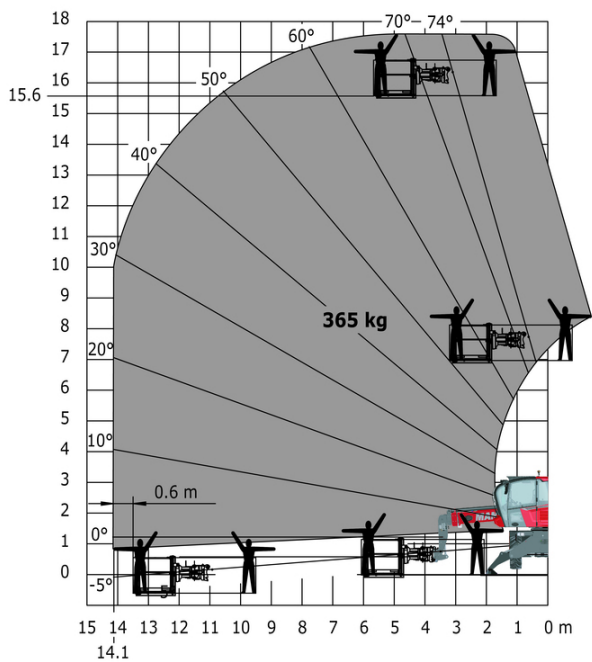

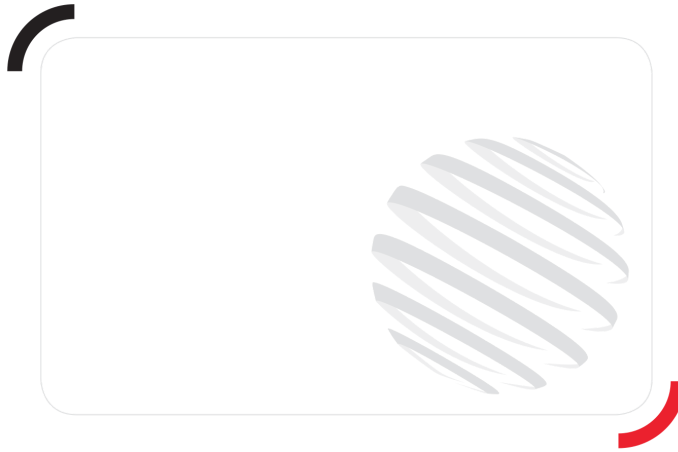

**Head Office**

B.P. 249 - 430 rue de l'Aubinière  
44150 Ancenis Cedex - France

Tel: +33 (0)2 40 09 10 11 - Fax: +33 (0)2 40 09 10 97

[www.manitou.com](http://www.manitou.com)



This publication provides a description of the configuration versions and options for Manitou products, which may differ for equipment. The equipment presented in this brochure may be part of a series, as an option, or it may not be available, depending on the versions. Manitou reserves the right, at any time and without notice, to amend the specifications described and represented. The specifications provided do not bind the manufacturer. For more details, please contact your Manitou agent. This is not a contractually binding document. The presentation of the products is not contractually binding. List of specifications non-exhaustive. The logos as well as the visual identity of the company are owned by Manitou and cannot be used without authorisation. All rights reserved. The photos and diagrams contained in this brochure are only provided for consultation and information purposes.

MANITOU BF SA - Limited company with board of directors - Share capital: 39,668,399 euros - 857 802 508 RCS Nantes