

Fiche technique :

MRT-X 2570

VISION +



 **MANITOU**
HANDLING YOUR WORLD

Capacités		Métrique
Capacité max.	Q	7000 kg
Hauteur de levage max.		24.80 m
Déport maximal		20.50 m
Poids et dimensions		
Longueur hors-tout (avec fourches)	l1	8.87 m
Longueur au talon des fourches	l2	7.67 m
Largeur hors tout	b1	2.50 m
Hauteur hors tout	h17	3.10 m
Largeur hors tout cabine	b4	0.96 m
Rayon de braquage (extérieures roues)	Wa1	4.63 m
Garde au sol	m4	0.36 m
Empattement	y	3.25 m
Angle de cavage	a4	12 °
Angle de déversement	a5	110 °
Rotation tourelle		360 °
Poids		21300 kg
Longueur de fourches / Largeur de fourches / Section de fourches	l / e / s	1200 mm x 125 mm x 60 mm
Roues		
Pneus standards		445/65 R22,5
Roues motrices (avant / arrière)		2 / 2
Mode de direction		2 roues directrices, 4 roues directrices, Mode crabe
Stabilisateurs		
Type de stabilisateurs		Télescopique duplex
Commandes pour stabilisateurs		Stabilisateurs à commande individuelle ou simultanée
Moteur		
Marque du moteur		Yanmar
Nome moteur		Stage IIIA
Modèle du moteur		4TN107FT-6SMU1
Puissance moteur (CV / kW)		173 ch / 127 kW
Couple max. / Régime moteur (min)		805 Nm @ 1500 tr/min
Nombre de cylindres - Cylindrée		4 - 4567 cm³
Système de refroidissement		Refroidissement par eau
Circuit électrique		
Nombre de batterie / Tension batterie		2 x 12 V
Capacité batterie 12V		120 Ah
Courant de démarrage des batteries		(EN)850 A
Transmission		
Type de transmission		Hydrostatique
Boîte de vitesses / Nombre de vitesses (avant) / Nombre de vitesses (arrière)		Speedshift / 2 / 2
Vitesse de déplacement max.		40 km/h
Effort de traction		9200 daN
Frein de parking		Frein de stationnement négatif automatique
Frein de service		Freinage multidisques à bain d'huile sur pont avant et arrière
Performances		
Pente franchissable (en charge / à vide)		32.40 % / 41.40 %
Hydraulique		
Type de pompe hydraulique		Pompe à débit variable
Débit hydraulique		172 l/min
Pression hydraulique		350 bar
Capacités des réservoirs		
Huile moteur		13 l
Carburant		320 l
Bruit et vibration		
Bruit au poste de conduite (LpA)		67 dB
Bruit à l'environnement (LwA)		108 dB
Vibration sur l'ensemble mains/bras		< 2.50 m/s²
Divers		
Roues directrices (avant / arrière)		2 / 2
Commandes		2 Joysticks
Certification cabine		Cabine ROPS - FOPS niveau 2
Système de reconnaissance automatique des accessoires (E-Reco)		Standard

MRT-X 2570 - Schémas d'encombrement



Autres données		Métrique	
Longueur du châssis		l14	5.92 m
Déport du contrepoids (tourelle à 90°)		a7	3.45 m
Longueur hors tout aux stabilisateurs		l12	5.62 m
Largeur hors tout stabilisateurs déployés		b7	6.04 m
Correcteur de dévers		a9	+/- 7°
Garde au sol sous les pneus avant sur stabilisateurs		m5	0.40 m

MRT-X 2570 - Abaques

Machine sur pneus avec fourches

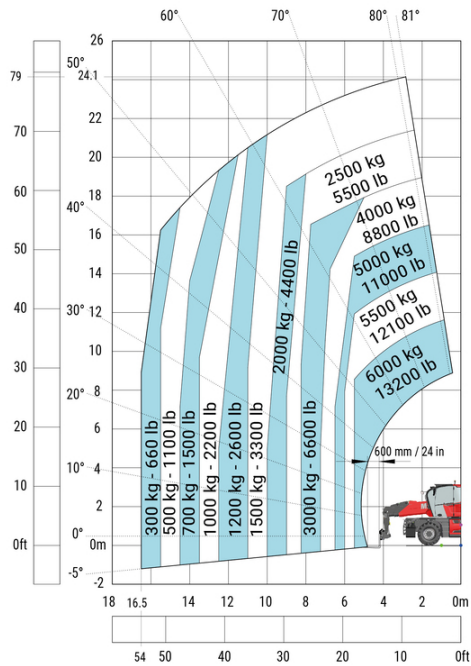

Machine sur stabilisateurs abaissés avec fourches

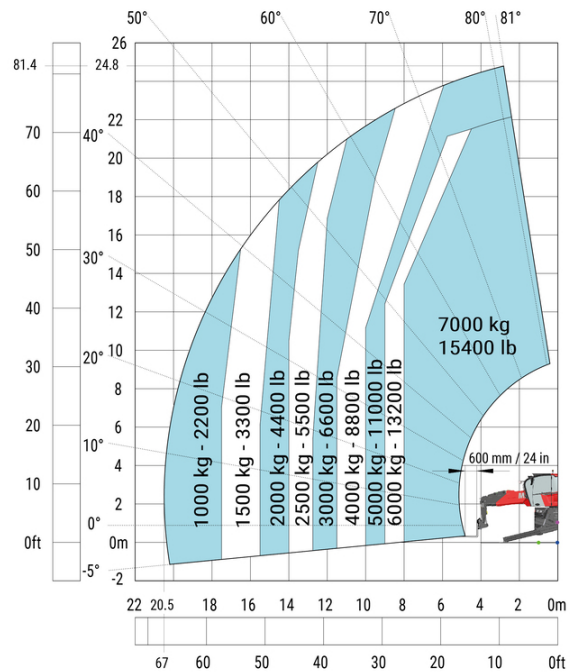

Machine sur stabilisateurs abaissés avec treuil 6000 kg (Métrique)

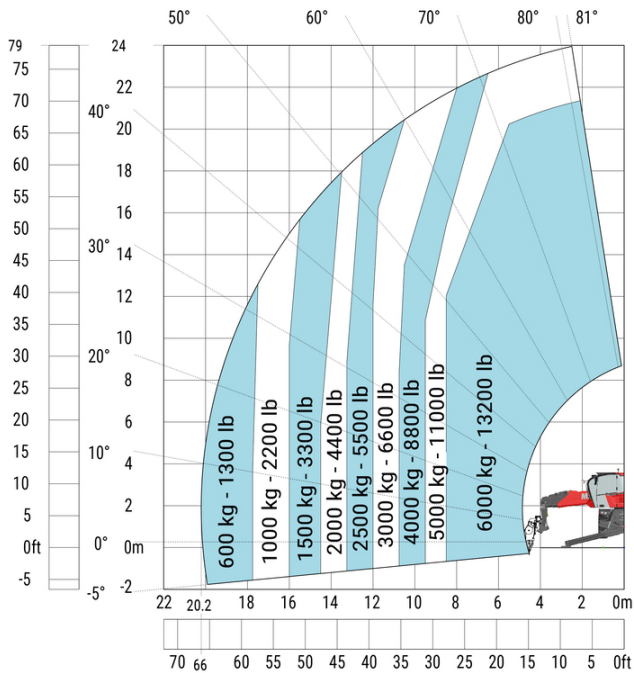

Machine sur stabilisateurs abaissés avec treuil 7200 kg (métrique)

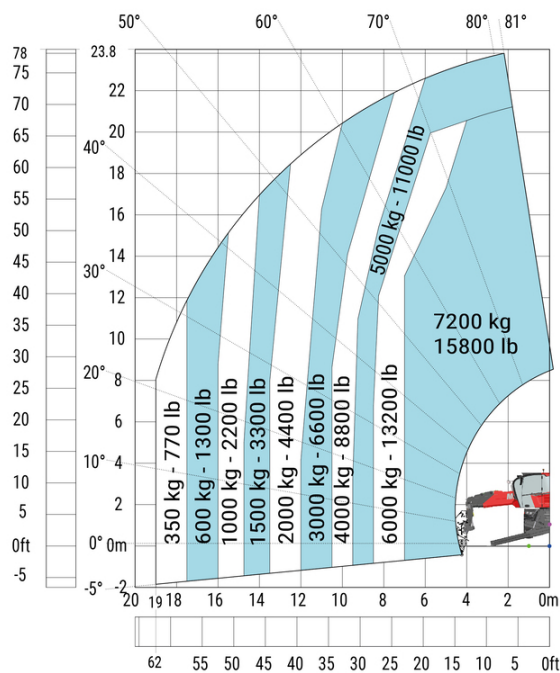

Machine sur stabilisateurs abaissés avec potence 1500 kg Machine sur stabilisateurs abaissés avec potence 2000 kg (Métrique)

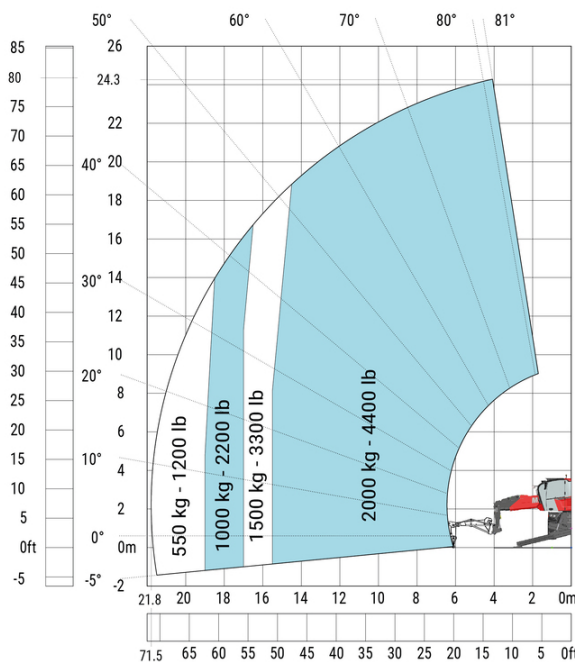
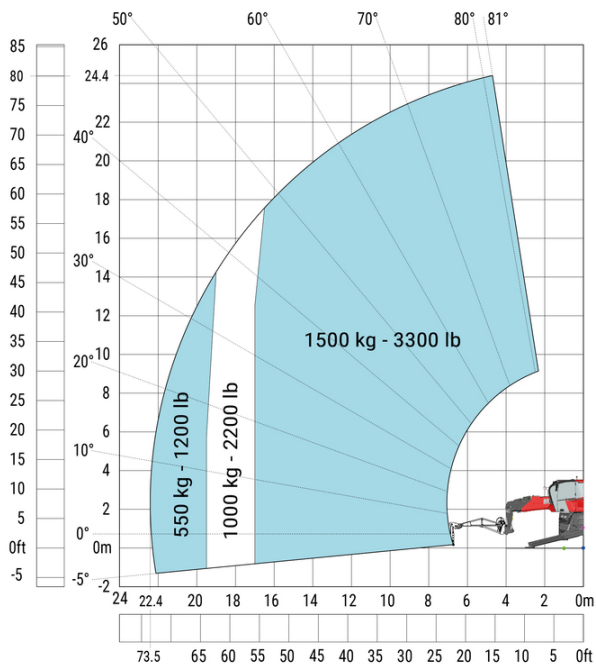

Machine sur stabilisateurs abaissés avec potence-treuil extensible (Métrique)

Machine sur stabilisateurs abaissés avec crochet 9000 kg (Métrique)

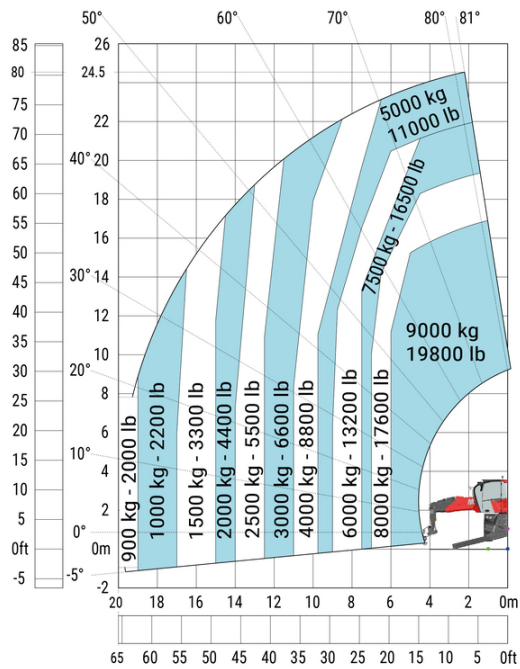
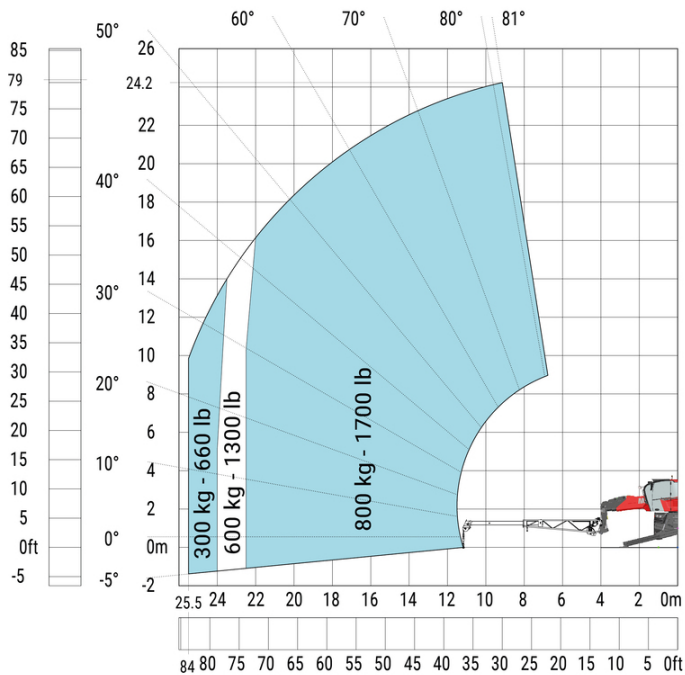

Machine sur stabilisateurs abaissés avec nacelle 365 kg

Machine sur stabilisateurs abaissés avec nacelle 1000 kg

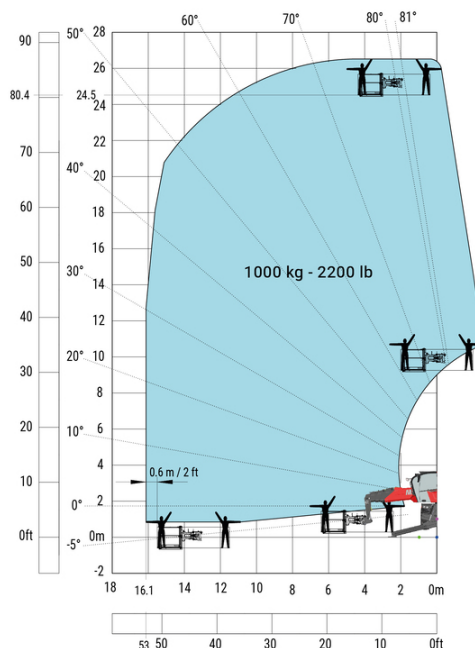
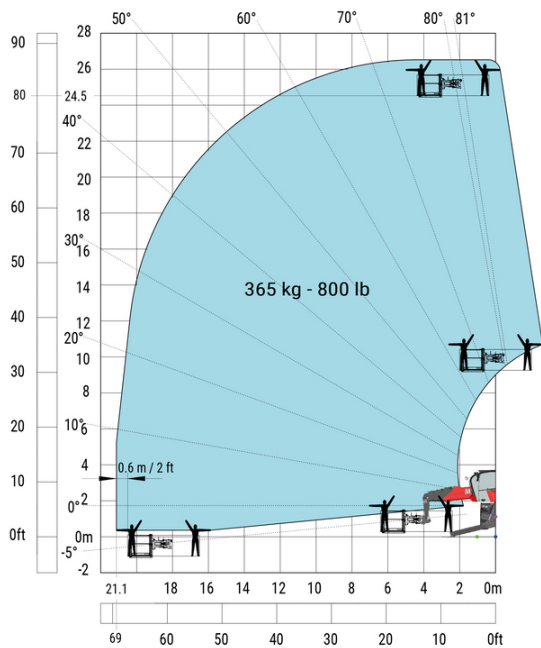



Siège Social

B.P. 249 - 430 rue de l'Aubinière
44150 Ancenis Cedex - France

Tel: +33 (0)2 40 09 10 11 - Fax: +33 (0)2 40 09 10 97

www.manitou.com



Cette publication présente le descriptif des versions et possibilités de configuration des produits Manitou qui peuvent différer en équipement. Les équipements présentés dans cette brochure peuvent être de série, en option, ou non disponibles suivant les versions. Manitou se réserve le droit, à tout moment et sans préavis, de modifier les spécifications décrites et représentées. Les spécifications portées n'engagent pas le constructeur. Pour plus de détails, contactez votre concessionnaire Manitou. Document non contractuel. Présentation des produits non contractuelle. Liste des spécifications non exhaustive. Les logos ainsi que l'identité visuelle de l'entreprise sont la propriété de Manitou et ne peuvent être utilisés sans autorisation. Tous droits réservés. Les photos et schémas contenus dans la présente brochure ne sont fournis qu'à des fins de consultation et à titre indicatif.

Manitou BF SA - Société anonyme à conseil d'administration - Capital social : 39 668 399 euros - 857 802 508 RCS Nantes