

Technical sheet :

# MT 1440 ST5

---



 **MANITOU**  
HANDLING YOUR WORLD

Capacities		Metric
Max. capacity	Q	4000 kg
Max. lifting height		13.53 m
Maximum outreach		9.46 m
Breakout force with bucket		7895 daN
Weight and dimensions		
Overall length to carriage	l11	6.02 m
Length to face of forks	l2	6.13 m
Overall width	b1	2.36 m
Overall height	h17	2.45 m
Wheelbase	y	3.07 m
Ground clearance	m4	0.37 m
Overall cab width	b4	0.89 m
Tilt-up angle	a4	12 °
Tilt-down angle	a5	114 °
External turning radius (over tyres)	Wa1	3.94 m
Unladen weight (with forks)		10940 kg
Overall weight		10940 kg
Tires type		Inflatable
Standard tires		Alliance 400/80 - 24 - 162A8
Forks length / width / section	l / e / s	1200 mm x 125 mm x 50 mm
Performances		
Lifting		16 s
Lowering		12.40 s
Extension		17.30 s
Retraction		13 s
Crowd		4.30 s
Dump		4 s
Engine		
Engine brand		Deutz
Engine norm		Stage V
Engine model		TCD 3.6L
Number of cylinders / Capacity of cylinders		4 - 3621 cm <sup>3</sup>
Engine power (Hp/kW)		100 Hp / 75 kW
Max. torque / Engine rotation		410 Nm @ 1600 rpm
Drawbar pull (Laden)		9930 daN
Transmission		
Transmission type		Torque converter
Number of gears (forward / reverse)		4 / 4
Max. travel speed		24.90 km/h
Parking brake		Automatic parking brake
Service brake		Oil-immersed multi-discs braking on front & rear axles
Hydraulics		
Hydraulic pump type		Gear pump
Hydraulic flow / Pressure		167 l/min-270 bar
Tank capacities		
Engine oil		10 l
Hydraulic oil		135 l
Diesel Exhaust fluid (AdBlue® type)		22.60 l
Fuel		140 l
Noise and vibration		
Noise at driving position (LpA)		79 dB
Noise to environment (LwA)		106 dB
Vibration on hands/arms		< 2.50 m/s <sup>2</sup>
Miscellaneous		
Steering wheels (front / rear)		2 / 2
Drive wheels (front / rear)		2 / 2
Cab certification		Cabin ROPS - FOPS level 2
Controls		JSM

### MT 1440 ST5 - Dimensional drawing

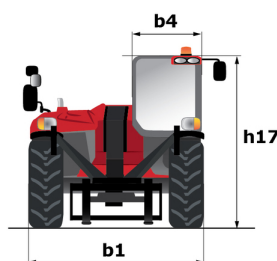

MT 1440 ST5 - Load chart

Machine on tires with forks - with levelling device Metric

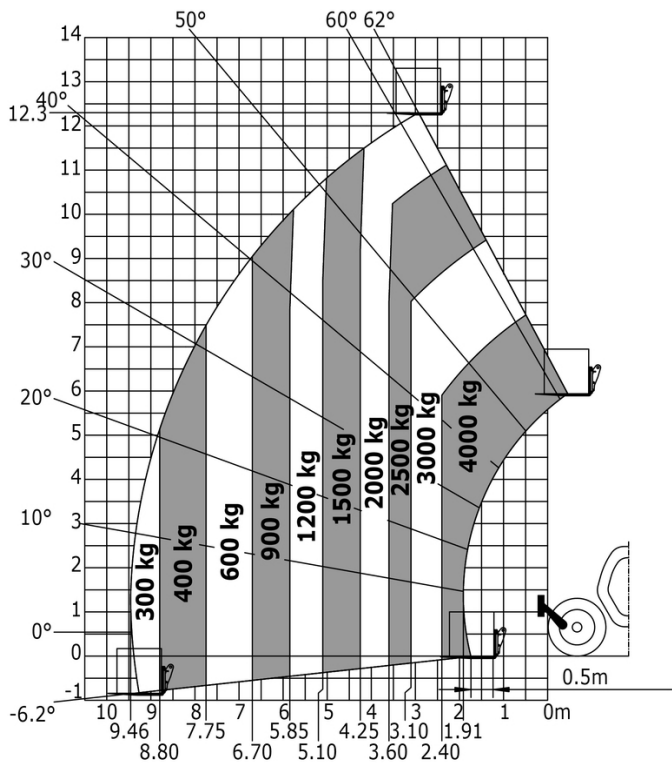

Machine on lowered stabilisers with forks Metric

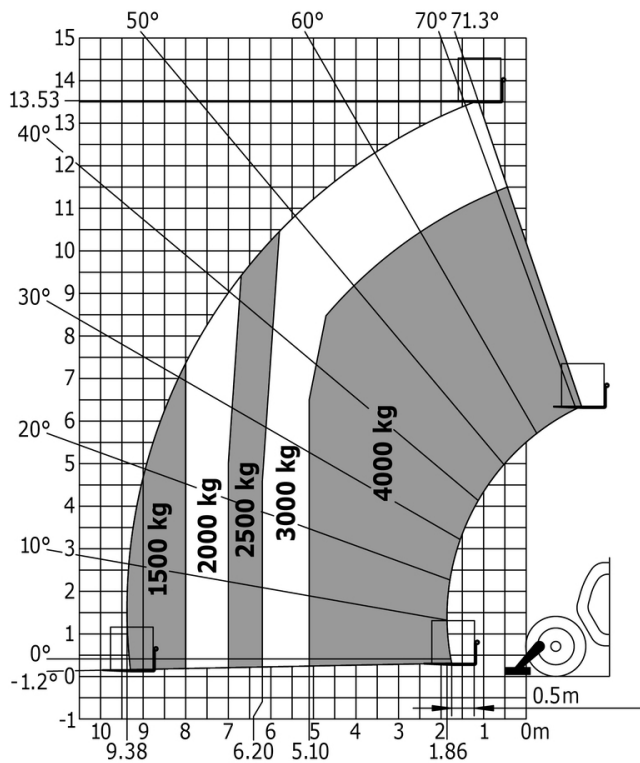



**Head Office**

B.P. 249 - 430 rue de l'Aubinière  
44150 Ancenis Cedex - France

Tel: +33 (0)2 40 09 10 11 - Fax: +33 (0)2 40 09 10 97

[www.manitou.com](http://www.manitou.com)



This publication provides a description of the configuration versions and options for Manitou products, which may differ for equipment. The equipment presented in this brochure may be part of a series, as an option, or it may not be available, depending on the versions. Manitou reserves the right, at any time and without notice, to amend the specifications described and represented. The specifications provided do not bind the manufacturer. For more details, please contact your Manitou agent. This is not a contractually binding document. The presentation of the products is not contractually binding. List of specifications non-exhaustive. The logos as well as the visual identity of the company are owned by Manitou and cannot be used without authorisation. All rights reserved. The photos and diagrams contained in this brochure are only provided for consultation and information purposes.

MANITOU BF SA - Limited company with board of directors - Share capital: 39,668,399 euros - 857 802 508 RCS Nantes