

Technical sheet :

MT 930 H



Capacities		Metric
Max. capacity	Q	3000 kg
Max. lifting height		8.85 m
Maximum outreach		6.05 m
Weight and dimensions		
Overall length to carriage	l11	4.67 m
Overall length (with forks)	l1	5.77 m
Overall width	b1	1.99 m
Overall height	h17	1.99 m
Wheelbase	y	2.69 m
Ground clearance	m4	0.35 m
Overall cab width	b4	0.79 m
Tilt-up angle	a4	11 °
Tilt-down angle	a5	116 °
External turning radius (over tyres)	Wa1	3.35 m
Unladen weight (with forks)		6550 kg
Overall weight		6550 kg
Tires type		Inflatable
Standard tires		Alliance - 380/75 R20 148A8 A580
Forks length / width / section	l / e / s	1070 mm x 100 mm x 50 mm
Performances		
Lifting		10.24 s
Lowering		7.95 s
Extension		9.89 s
Retraction		9.48 s
Crowd		3.06 s
Dump		2.44 s
Engine		
Engine brand		Kubota
Engine norm		Stage V
Engine model		V3307-CR-TEW05
Number of cylinders / Capacity of cylinders		4 - 3331 cm³
Engine power (Hp/kW)		75 Hp / 54.60 kW
Max. torque / Engine rotation		263 Nm @ 1400 rpm
Drawbar pull (Laden)		3860 daN
Transmission		
Transmission type		Hydrostatic
Number of gears (forward / reverse)		2 / 2
Max. travel speed		24.90 km/h
Service brake		Hydraulic
Hydraulics		
Hydraulic pump type		Gear pump
Hydraulic flow / Pressure		88 l/min-245 bar
Tank capacities		
Engine oil		11 l
Hydraulic oil		115 l
Fuel		90 l
Noise and vibration		
Noise at driving position (LpA)		74 dB
Noise to environment (LwA)		103 dB
Vibration on hands/arms		< 2.50 m/s²
Miscellaneous		
Steering wheels (front / rear)		2 / 2
Cab certification		Cabin ROPS - FOPS level 2

MT 930 H - Dimensional drawing



MT 930 H - Load chart

Machine on tires with forks Metric

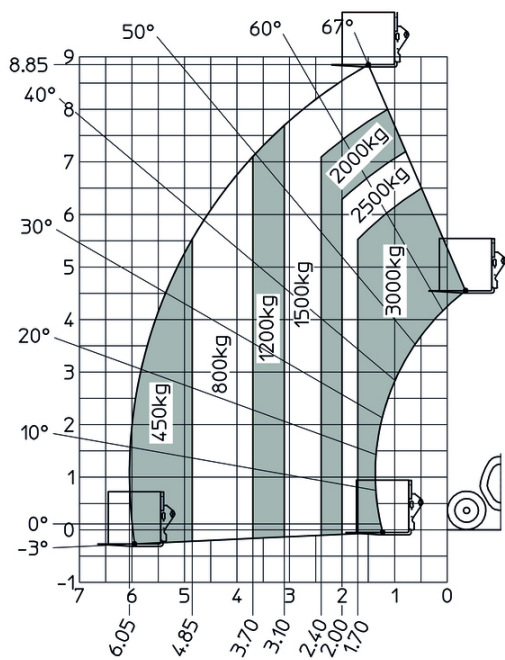

**Head Office**

B.P. 249 - 430 rue de l'Aubinière
44150 Ancenis Cedex - France

Tel: +33 (0)2 40 09 10 11 - Fax: +33 (0)2 40 09 10 97

www.manitou.com



This publication provides a description of the configuration versions and options for Manitou products, which may differ for equipment. The equipment presented in this brochure may be part of a series, as an option, or it may not be available, depending on the versions. Manitou reserves the right, at any time and without notice, to amend the specifications described and represented. The specifications provided do not bind the manufacturer. For more details, please contact your Manitou agent. This is not a contractually binding document. The presentation of the products is not contractually binding. List of specifications non-exhaustive. The logos as well as the visual identity of the company are owned by Manitou and cannot be used without authorisation. All rights reserved. The photos and diagrams contained in this brochure are only provided for consultation and information purposes.

MANITOU BF SA - Limited company with board of directors - Share capital: 39,668,399 euros - 857 802 508 RCS Nantes