

Ficha técnica :

3300V NXT2



 **MANITOU**
HANDLING YOUR WORLD

Capacidad		Métrico
Capacidad de operación nominal		1497 kg
Peso sin carga		4087 kg
Peso y dimensión		
Distancia entre ejes	y	1257 mm
Altura de elevación: totalmente elevada	h27	4369 mm
Altura hasta bisagra - elevación completa	h28	3332 mm
Altura total al techo	h17	2083 mm
Ángulo de vertido a altura máxima	a5	42 °
Altura de descarga	h29	2502 mm
Cubo de longitud completa	l16	3874 mm
Alcance de descarga a la altura máxima	r6	813 mm
Retroceso en suelo	a13	29 °
Altura del asiento al suelo	h30	1041 mm
Ancho total: sin cucharón	b1	1829 mm
Anchura de cazo	e1	1880 mm
Distancia al suelo	m4	229 mm
Longitud total: sin cucharón	l2	3023 mm
Ángulo de inclinación	a2	25 °
Radio de giro exterior: frente del cucharón	b18	2400 mm
Rendimiento		
Velocidad de desplazamiento (en vacío)		13 km/h
Velocidad de desplazamiento con opción de dos velocidades: máxima		19.60 km/h
Neumáticos		
Modelos de los neumáticos		14,00 x 17,5 HD
Motor		
Marca		Yanmar
Modelo de motor		4TNV98CT-NMS
Par máx. / Rotación del par de motor		294 Nm / 2500 rpm
Fuente de alimentación		Diésel
Potencia del motor (CV / kW)		72 Hp / 52.70 kW
Batería		12 V
Alternador		95 kW
Motor de arranque		3 kW
Hidráulico		
Sistema hidráulico auxiliar		89.10 l/min
Presión Hidráulica Auxiliar		237.90 bar
Sistema hidráulico auxiliar de alto flujo - Opción (L / min)		132 l/min
Presión hidráulica auxiliar de alto flujo - opción		220.60 bar
Capacidad del tanque		
Carburante		92.70 l
Capacidad del depósito hidráulico		40 l
Cilindrada		3.30 l
Ruido y vibración		
Ruido en el entorno (LwA)		101 dB
Ruido en el puesto de conducción (LpA)		85 dB
Vibración de todo el cuerpo (ISO 2631-1)		0.79 m/s ²
Vibraciones en manos/brazos		< 1.20 m/s ²

3300V NXT2 - Diagrama dimensional

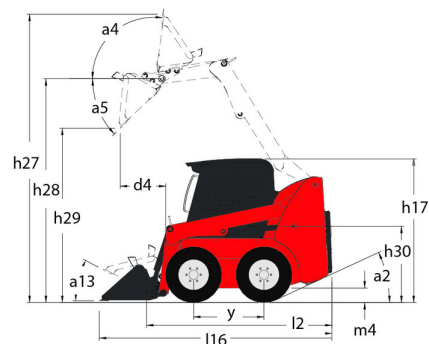

Equipamiento

—	
Placa de acceso integral (extraíble)	Estándar
Estación del operador	
Aire acondicionado con ajuste manual	Opcional
Asiento ajustable de respaldo alto	Estándar
Asiento con suspensión - Mecánico	Opcional
Asiento con suspensión neumática	Opcional
Cabina cerrada	Opcional
Calefacción	Opcional
Claxon	Estándar
Controles de barra en T Gehl	Opcional
Controles dobles	Opcional
Mandos de mano/pie	Opcional
Mandos joystick	Opcional
Material de reducción acústica	Estándar
Pedales de acelerador para pie y mano 2	Estándar
Protección Superior ROPS/FOPS Nivel II	Estándar
Reposabrazos Ajustables / Torres de Control 1	Estándar
Funciones secundarias	
Contrapeso	Estándar
Hydraglide™ Control de Marcha 3	Estándar
Instrumentación Completa	Estándar
Función de elevación	
Hidráulica auxiliar	Estándar
Hidráulica Auxiliar de Alto Caudal	Opcional
Sistema de Montaje de Accesorios All-Tach®	Estándar
Sistema de Montaje de Accesorios Power-A-Tach®	Opcional
Iluminación	
Luces de trabajo - Delanteras y traseras	Estándar
Motorización/Potencia	
Calentador de bloque motor	Opcional
Motor con turbocompresor	Estándar
Sistema de Apagado Automático del Motor	Estándar
Transmisión de dos velocidades	Estándar
Otras opciones	
Acción Hidráulica de Elevación Autonivelante Selectiva 4	Opcional
Transmisión Hidrostática - Servo	Estándar
Seguridad	
Alarma de marcha atrás	Opcional
Barra de Retención del Operador	Estándar
Control de freno (Automático / Manual)	Estándar
Dispositivo de soporte del brazo de elevación	Estándar
Protección Antivandálica	Estándar
Sistema de Seguridad Hydraloc™	Estándar



 **MANITOU**
HANDLING YOUR WORLD

Oficina Central

B.P. 249 - 430 rue de l'Aubinière

44150 Ancenis Cedex - Francia

Tel.: 00 33 (0)2 40 09 10 11 - Fax: 00 33 (0)2 40 09 10 97

www.manitou.com



Esta publicación describe las versiones y posibilidades de configuración de los productos Manitou que puedan diferir en equipamiento. Los equipamientos presentados en este folleto pueden ser de serie, opcionales o no estar disponibles en algunas versiones. Manitou se reserva el derecho, en cualquier momento y sin previo aviso, de modificar las especificaciones descritas y representadas. Las especificaciones aportadas no comprometen al fabricante. Para más información, póngase en contacto con su concesionario Manitou. Documento no contractual. Presentación de los productos no contractual. Lista de especificaciones no exhaustiva. Los logos y la identidad visual de la empresa son propiedad de Manitou y no pueden ser utilizados sin autorización. Todos los derechos reservados. Las fotos y los esquemas contenidos en este folleto se ofrecen para consulta y a título indicativo solamente.

Manitou BF SA - Sociedad anónima con Consejo de Administración - Capital social: 39 668 399 euros - 857 802 508 RCS Nantes