

Technical sheet :

1050RT



 **MANITOU**
HANDLING YOUR WORLD

| Capacities | | Metric |
|---|-----|--------------------|
| Operating Weight | | 2141 kg |
| Unladen weight | | 1928 kg |
| Operating Capacity at 35% Tipping Load | | 476 kg |
| Operating Capacity At 50% Tipping Load | | 680 kg |
| Tipping capacity | | 1361 kg |
| Weight and dimensions | | |
| Overall Operating Height - Fully Raised | h27 | 3650 mm |
| Height to Hinge Pin - Fully Raised | h28 | 2769 mm |
| Dump reach - Full height | r6 | 673.10 mm |
| Dump angle at full height | a5 | 38 ° |
| Dump Height - Fully Raised | h29 | 2134 mm |
| Maximum Rollback Angle - Fully Raised | a4 | 102 ° |
| Overall Height to top of ROPS | h17 | 1816 mm |
| Overall length with bucket | l16 | 2985 mm |
| Overall Length without Bucket | l1 | 2258 mm |
| Specified Height | h31 | 1466 mm |
| Reach at Specified Height | r4 | 991 mm |
| Dump angle at specified height | a17 | 72 ° |
| Carry Position | d5 | 127 mm |
| Maximum Rollback Angle at Carry Position | a14 | 32 ° |
| Digging Position | h32 | 0 mm |
| Angle of Departure with STD Counterweight | | 35 ° |
| Ground clearance | m4 | 191 mm |
| Track gauge | b10 | 1039 mm |
| Track Shoe Width | b20 | 250 mm |
| Crawler base | y2 | 1283 mm |
| Overall width less bucket | b1 | 1290 mm |
| Bucket Width | e1 | 1372 mm |
| Clearance Radius - Front with Bucket | b18 | 1854 mm |
| Angle of Approach | a3 | 90 ° |
| Grouser Height | | 25 mm |
| Track Type / Track Rollers / Roller Type | | Rubber / 4 / Steel |
| Performances | | |
| Ground Speed - Single Speed | | 10.10 km/h |
| Drawbar Pull/Tractive Effort | | 1996 kg |
| Bucket Breakout - Tilt Cylinder | | 1346 kg |
| Bucket Breakout - Lift Cylinder | | 1376 kg |
| Engine | | |
| Engine brand | | Yanmar |
| Engine model | | 3TNV88C-KMSV |
| Motor Type | | Radial Piston |
| Engine power (Hp) | | 34.20 Hp |
| Engine power (kW) | | 23.70 kW |
| Max. torque | | 109.40 Nm |
| Battery voltage | | 12 V |
| Cold Cranking Amps at Temperature (CCA) | | 800 A |
| Alternator - Voltage / Ampere | | 12 V / 55 A |
| Hydraulics | | |
| Standard flow - Auxiliary hydraulics | | 55 l/min |
| Tank capacities | | |
| Oil Pan Capacity | | 5.87 l |
| Hydraulic tank capacity | | 30 l |
| Fuel | | 36 l |
| Cooling liquid | | 6.62 l |
| Displacement / Number of cylinders | | 1.64 l / 3 |
| Noise and vibration | | |
| Noise to environment (LwA) | | 101 dB |
| Noise at driving position (LpA) | | 85.80 dB |
| Miscellaneous | | |
| Ground Pressure | | 0.33 bar |

1050RT - Dimensional drawing

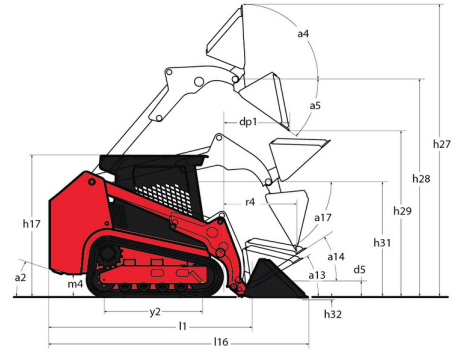

Equipment

| | |
|--|----------|
| Lifting function | |
| All-Tach® Attachment Mounting System | Standard |
| Auxiliary Hydraulics | Standard |
| IdealTrax® automatic track tensioning system | Standard |
| Motorization/Power | |
| Combination Radiator & Hydraulic Oil Cooler | Standard |
| Dual-Element Air Cleaner with Indicator | Standard |
| Engine Auto-Shutdown System | Optional |
| Glowplugs Starts Assist | Standard |
| Operator station | |
| Foot Throttle | Standard |
| Full-Suspension Seat | Optional |
| Multi-Function Display Screen | Standard |
| ROPS/FOPS Level II Overhead Guard | Standard |
| Sliding Side Windows | Standard |
| Swing-out Cab Door | Standard |
| Other options | |
| Selectable Self-Leveling Hydraulic Lift Action 4 | Optional |
| Pneumatics | |
| Rubber Track Undercarriage System | Standard |
| Secondary functions | |
| Counterweight | Standard |
| Dedicated Undercarriage | Standard |
| Security | |
| Anti-Vandalism Protection | Standard |
| Back-Up Alarm | Standard |
| Easy Manager | Standard |
| Engine Alert System with Error Display | Standard |
| Mechanical Lift Cylinder Lock | Standard |



Head Office

B.P. 249 - 430 rue de l'Aubinière
44150 Ancenis Cedex - France

Tel: +33 (0)2 40 09 10 11 - Fax: +33 (0)2 40 09 10 97

www.manitou.com



This publication provides a description of the configuration versions and options for Manitou products, which may differ for equipment. The equipment presented in this brochure may be part of a series, as an option, or it may not be available, depending on the versions. Manitou reserves the right, at any time and without notice, to amend the specifications described and represented. The specifications provided do not bind the manufacturer. For more details, please contact your Manitou agent. This is not a contractually binding document. The presentation of the products is not contractually binding. List of specifications non-exhaustive. The logos as well as the visual identity of the company are owned by Manitou and cannot be used without authorisation. All rights reserved. The photos and diagrams contained in this brochure are only provided for consultation and information purposes.

MANITOU BF SA - Limited company with board of directors - Share capital: 39,668,399 euros - 857 802 508 RCS Nantes