

Technical sheet :

M-X 50-4



 **MANITOU**
HANDLING YOUR WORLD

Technical characteristics		Metric	
1.1	Manufacturer		Manitou
1.2	Model Name		M-X 50-4
1.3	Power source		Diesel
1.4	Operator type		Seated
1.5	Max. capacity	Q	5000 kg
1.6	Load center of gravity	c	600 mm
1.8	Load distance, centre of drive axle to fork	x	762 mm
1.9	Wheelbase	y	2120 mm
Weight			
2.1	Service weight		7660 kg
2.2	Weight on front axle (laden) / rear axle (laden)		10800 kg / 1869 kg
2.3	Weight on front axle (Unladen) / rear axle (Unladen)		2570 kg / 5090 kg
Wheels			
3.1	Tires type		Pneumatic
3.3	Dimensions of rear wheels		340/80R18 XMCL 143A8
3.5	Number of front wheels / rear wheels		2 / 2
3.5.2	Number of drive wheels		4
3.6	Front wheel gauge	b10	1620 mm
Dimensions			
4.7	Height of overhead guard (cabin)	h6	2495 mm
4.19	Overall length	l1	4945 mm
4.20	Length to face of forks	l2	3745 mm
4.21	Overall width	b1	2080 mm
4.22	Forks section x width x length	s / e / l	50 mm x 150 mm / 1200 mm
4.23	Fork carriage ISO 2328 (class/form) A/B		4A
4.24	Fork carriage width	b3	1670 mm
4.31	Ground clearance below mast	m1	265 mm
4.32	Ground clearance at centre of wheelbase	m2	375 mm
4.35	Turning radius	Wa	4155 mm
Performances			
5.1	Travel speed (laden / unladen)		24 km/h / 23.40 km/h
5.2	Lifting speed (laden / unladen)		0.40 m/s / 0.50 m/s
5.3	Lowering speed (laden / unladen)		0.40 m/s / 0.40 m/s
5.5	Drawbar pull (Laden / Unladen)		10360 daN / 6205 daN
5.10	Service brake		Hydraulic
	Transmission type		Torque converter
Engine			
7.1	Engine brand / model / norm		Perkins / 1104D-44T NL38894 / Stage IIIA
7.2	Engine power (Hp / kW)		95 Hp/70 kW
7.3	Rated speed		2360 rpm
Miscellaneous			
8.1	Type of drive control		Hydraulic
8.2	Working hydraulic pressure for attachments		210 bar
8.3	Oil flow rate for attachments		87 l/min

M-X 50-4 - Dimensional drawing

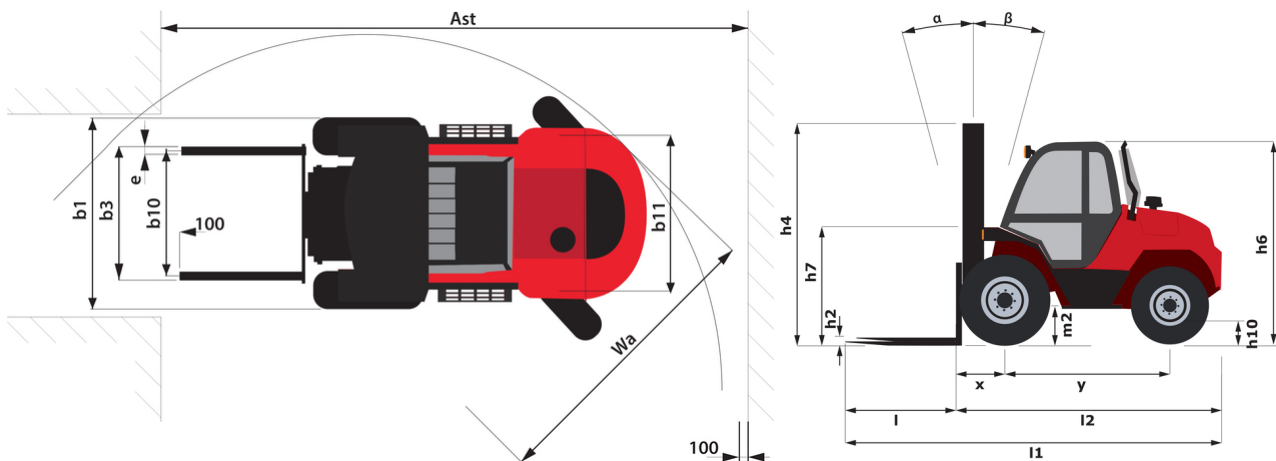



 **MANITOU**
HANDLING YOUR WORLD

Head Office

B.P. 249 - 430 rue de l'Aubinière
44150 Ancenis Cedex - France

Tel: +33 (0)2 40 09 10 11 - Fax: +33 (0)2 40 09 10 97

www.manitou.com



This publication provides a description of the configuration versions and options for Manitou products, which may differ for equipment. The equipment presented in this brochure may be part of a series, as an option, or it may not be available, depending on the versions. Manitou reserves the right, at any time and without notice, to amend the specifications described and represented. The specifications provided do not bind the manufacturer. For more details, please contact your Manitou agent. This is not a contractually binding document. The presentation of the products is not contractually binding. List of specifications non-exhaustive. The logos as well as the visual identity of the company are owned by Manitou and cannot be used without authorisation. All rights reserved. The photos and diagrams contained in this brochure are only provided for consultation and information purposes.

MANITOU BF SA - Limited company with board of directors - Share capital: 39,668,399 euros - 857 802 508 RCS Nantes