

Technical sheet :

MLT-X 735 T LSU



Capacities		Metric
Max. capacity	Q	3500 kg
Max. lifting height		6.90 m
Maximum outreach		3.90 m
Reach at max. height		1 m
Breakout force with bucket		6825 daN
Weight and dimensions		
Unladen weight (with forks)		7075 kg
Ground clearance	m4	0.44 m
Wheelbase	y	2.81 m
Overall length to carriage (with hitch)	l11	4.79 m
Overall length to carriage (without hitch)	l3	4.76 m
Front overhang		1.19 m
Overall width	b1	2.40 m
Overall cab width	b4	0.98 m
Overall height	h17	2.30 m
Tilt-down angle	a5	134 °
Tilt-up angle	a4	13 °
External turning radius (over tyres)	Wa1	3.86 m
Standard tires		Alliance - A580 - 460/70 R24 159A8
Drive wheels (front / rear)		2 / 2
Steering mode		Manicrab, 2 wheel steer, 4 wheel steer, Crab mode
Performances		
Lifting		7.30 s
Lowering		5.60 s
Extension		8.20 s
Retraction		6.60 s
Crowd		3.20 s
Dump		2.70 s
Engine		
Engine brand		Perkins
Engine nom		Stage IIIA
Max. fuel sulphur content		5000 ppm
Engine model		1104D-44 TA
Number of cylinders - Capacity of cylinders		4 - 4400 cm³
Engine power (Hp / kW)		101 Hp / 74.50 kW
Max. torque / Engine rotation		410 Nm @1400 rpm
Drawbar pull (Laden)		8200 daN
Reversible fan		Standard
Transmission		
Transmission type		Torque converter
Gearbox		Powershuttle
Number of gears (forward / reverse)		4 / 4
Max. travel speed (may vary according to applicable regulations)		35 km/h
Differential lock		Limited slip differential on front axle
Parking brake		Manual
Service brake		Oil-immersed multi-discs on front & rear axles
Hydraulics		
Hydraulic pump type		Variable displacement pump
Hydraulic flow - Pressure		108 l/min - 270 bar
Flow sharing distributor		Standard
Tank capacities		
Hydraulic tank capacity		135 l
Fuel		120 l
Noise and vibration		
Noise at driving position (LpA) tested following NF EN 12053 nom		76 dB
Noise to environment (LWA)		104 dB
Vibration on hands/arms		< 2.50 m/s²
Miscellaneous		
Tractor homologation		
Controls		JSM

Optional tires tab

	Overall height	Overall width
ALLIANCE - A570 - 17,5 LR24	-	-
NOKIAN - TRI STEEL - 460/65 R24 156A8	2.27 m	2.38 m
MICHELIN - XHA - 15.5 R25 158A2	2.28 m	2.38 m

Options / Finishing

S : Standard / O : Optional / - : Not available

	Classic	Premium	Elite
Lifting function			
Boom suspension "Active CRC"	0	0	S
Continuous flow hydraulics	0	0	0
Electric supply - 12V - On the top of the boom (Fixed part)	0	0	0
Hydraulic attachment locking	0	0	0
Return pipe to hydraulic oil tank	0	0	0
Operator station			
Air conditioning with manual adjustment	0	S	S
Air suspension cloth-covered seat	0	S	-
Bluetooth CD MP3 radio	0	0	S
CD MP3 car radio	0	S	-
Cyclonic air pre-filter	S	S	0
Low frequency air suspension cloth seat with heating	0	0	S
Mechanical cloth-covered seat	S	-	-
Tuner car radio - 50W	S	-	-
Motorization/Power			
Attachment hydraulic flow control system	0	0	0
Continuous flow hydraulics	0	0	0
Self-cleaning air pre-filter	0	0	S
Secondary functions			
1 pair of pre-fitted double action rear hydraulic couplers	0	0	0
Automatic rotating towing hitch on counterweight	0	0	0
Manual rotating towing hitch	S	S	S
Lighting			
LED front work lights + LED rear work lights	0	0	0
Work lights on boom head (x2)	0	0	0
Security			
Audio warning on reverse	0	0	0

MLT-X 735 T LSU - Dimensional drawing



MLT-X 735 T LSU - Load chart

Machine on tires with forks Metric

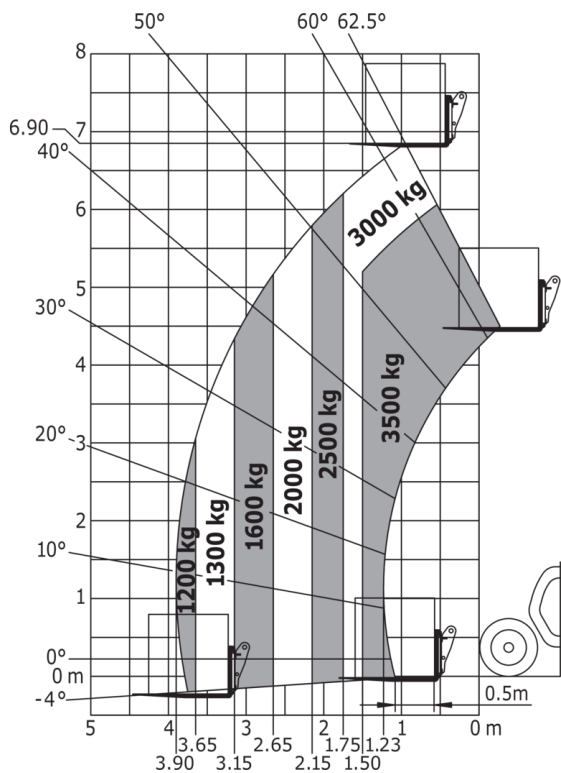

Machine on tires with forks LC 600 mm Metric

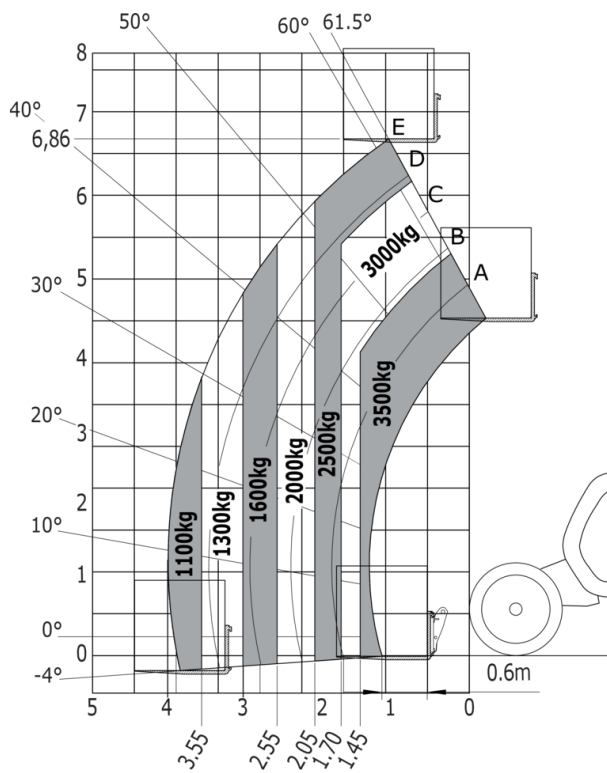



Head Office

B.P. 249 - 430 rue de l'Aubinière
44150 Ancenis Cedex - France

Tel: +33 (0)2 40 09 10 11 - Fax: +33 (0)2 40 09 10 97

www.manitou.com



This publication provides a description of the configuration versions and options for Manitou products, which may differ for equipment. The equipment presented in this brochure may be part of a series, as an option, or it may not be available, depending on the versions. Manitou reserves the right, at any time and without notice, to amend the specifications described and represented. The specifications provided do not bind the manufacturer. For more details, please contact your Manitou agent. This is not a contractually binding document. The presentation of the products is not contractually binding. List of specifications non-exhaustive. The logos as well as the visual identity of the company are owned by Manitou and cannot be used without authorisation. All rights reserved. The photos and diagrams contained in this brochure are only provided for consultation and information purposes.

MANITOU BF SA - Limited company with board of directors - Share capital: 39,668,399 euros - 857 802 508 RCS Nantes