

Technical sheet :

KLEOS HM 500 D18



 **MANITOU**
HANDLING YOUR WORLD

| Technical characteristics | | | Metric |
|---------------------------|---|----|---------------------|
| 1.1 | Manufacturer | | Manitou |
| 1.2 | Model Name | | HM 500 D18 |
| 1.3 | Power source | | Manual |
| 1.4 | Operator type | | Pedestrian |
| 1.5 | Max. capacity | Q | 500 kg |
| 1.6 | Load center of gravity | c | 250 mm |
| Weight | | | |
| 2.1 | Overall weight without tools | | 178 kg |
| Wheels | | | |
| 3.1 | Tires type | | Nylon |
| 3.2 | Dimensions of front wheels | | 2x (75x65) |
| 3.3 | Dimensions of rear wheels | | 2x (150x50) |
| Dimensions | | | |
| 4.2 | Mast lowered height | h1 | 1600 mm |
| 4.5 | Mast extended height | h4 | 1780 mm |
| 4.19 | Overall length | l1 | 1300 mm |
| 4.20 | Length to face of forks | l2 | 575 mm |
| 4.21 | Overall width | b1 | 710 mm |
| 4.25 | Fork spread | b5 | 519 mm |
| 4.32 | Ground clearance at centre of wheelbase | m2 | 35 mm |
| Performances | | | |
| 5.2 | Lifting speed (laden / unladen) | | 0.10 m/s / 0.10 m/s |
| 5.3 | Lowering speed (laden / unladen) | | 0.10 m/s / 0.10 m/s |
| 5.11 | Parking brake | | Mecanic |

Kleos HM 500 D18 - Dimensional drawing

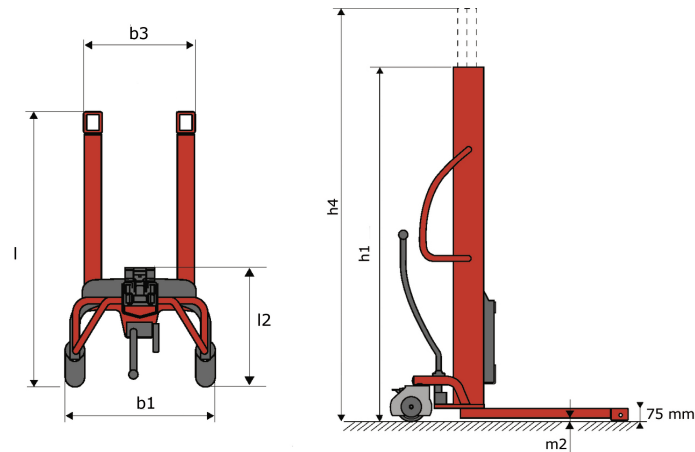

Tool characteristics

| Tool 500 kg | Attachment capacity | Center of gravity of load | A1 | A2 | B | B1 | C | D | E | E1 | E2 | F | Weight |
|-------------|---------------------|---------------------------|------|------|------|-----|-----|-----|----|-----|-----|-----|--------|
| | kg | mm | mm | mm | mm | mm | mm | mm | mm | mm | mm | mm | kg |
| EPE 500 | 500 | 350 | 700 | 715 | 50 | - | 252 | - | - | - | - | 320 | 30 |
| FA 500 | 500 | 350 | 700 | 745 | - | 250 | 680 | 45 | 60 | 30 | - | 720 | 54 |
| FR 500 | 500 | 600 | 1150 | 1177 | 560 | 200 | 315 | 85 | - | 70 | - | 700 | 68 |
| FUT 500 | 300 | 600 | 795 | 650 | 1057 | 350 | 650 | 245 | - | 240 | 631 | - | 92 |
| PLF 500 | 500 | 350 | 700 | 727 | 600 | - | 280 | - | 91 | - | - | 630 | 50 |
| POT 500 | 250 | 600 | 625 | 652 | 50 | - | 150 | - | - | - | - | 320 | 25 |

Tools

EPE 500



FA 500



FR 500



FUT 500



PLF 500



POT 500





Head Office

B.P. 249 - 430 rue de l'Aubinière

44150 Ancenis Cedex - France

Tel: +33 (0)2 40 09 10 11 - Fax: +33 (0)2 40 09 10 97

www.manitou.com



This publication provides a description of the configuration versions and options for Manitou products, which may differ for equipment. The equipment presented in this brochure may be part of a series, as an option, or it may not be available, depending on the versions. Manitou reserves the right, at any time and without notice, to amend the specifications described and represented. The specifications provided do not bind the manufacturer. For more details, please contact your Manitou agent. This is not a contractually binding document. The presentation of the products is not contractually binding. List of specifications non-exhaustive. The logos as well as the visual identity of the company are owned by Manitou and cannot be used without authorisation. All rights reserved. The photos and diagrams contained in this brochure are only provided for consultation and information purposes.

MANITOU BF SA - Limited company with board of directors - Share capital: 39,668,399 euros - 857 802 508 RCS Nantes